

(PL) Instrukcja montażu

(CZ) Návod k montáži

(D) Montageanleitung

(GB) Assembly instruction

(F) Model d'emploi

(HU) Szerelési útmutató

(I) Istruzione di montaggio

(NL) Handleiding voor de montage

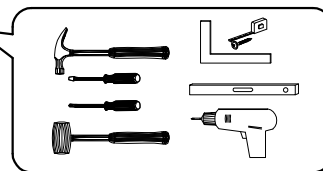
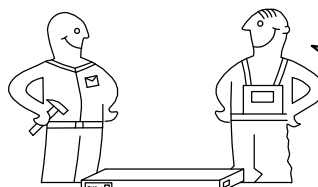

(RU) Инструкция по монтажу

(RO) Instrucțiuni de montare

(SK) Návod k montáži

(TR) Montaj talimatı

**⚠ Uwaga • Upozornění • Achtung • Attention • Caution • Figyelem
Attenzione • Opgelet • Внимание • Atenție • Upozornenie • Dikkat ⚠**

PL Czyszczenie należy wykonać wyłącznie za pomocą ściereczki lub lekko nawilżonego ręcznika. Nie stosować środków czyszczących do szorowania.

CZ Čistění je nutné vykonávat výhradně pomocí utěrky nebo lehké navlhčeného ručníku. Nepoužívejte čisticí prostředky obsahující abrazivní částice.

D Bitte nur mit einem Staubtuch oder leicht feuchtem Lappen reinigen. Keine scheuernden Putzmittel verwenden.

GB Please only clean with a duster or a damp cloth. Do not use any abrasive cleaners.

F Le nettoyage se fait uniquement à l'aide d'un torchon ou d'une serviette légèrement mouillée.

HU A tisztítás kizárólag törölrúha vagy enyhén nedvesített törölköző segítségével végezhető. Súroló hatású tisztítószerket nem szabad használni.

I Pulire esclusivamente con un panno o un asciugamano umido.

NL Reinig alleen met een stofdoek of een lichtjes vochtige doek. Gebruik geen schurende poetsmiddelen.

RU Очищайте от пыли тряпкой или слегка влажной ветошью. Не допускается применение чистящих средств, не предназначенных для ухода за мебелью.

RO Curățarea trebuie efectuată numai cu o cârpă sau cu un prosop ușor umezit. Nu utilizați agenți de curățare abrazivi.

SK Čistení je nutné vykonávať výhradne pomocí utierky alebo ľahko zvlhnutým ručníkom. Nepoužívajte čistiace prostriedky obsahujúci abrazívni častice.

TR Lütfen sadece bir toz bezile veya hafif nemli yumuşak bir bezle siliniz. Aşındırıcı temizlik malzemeleri kullanmayınız.

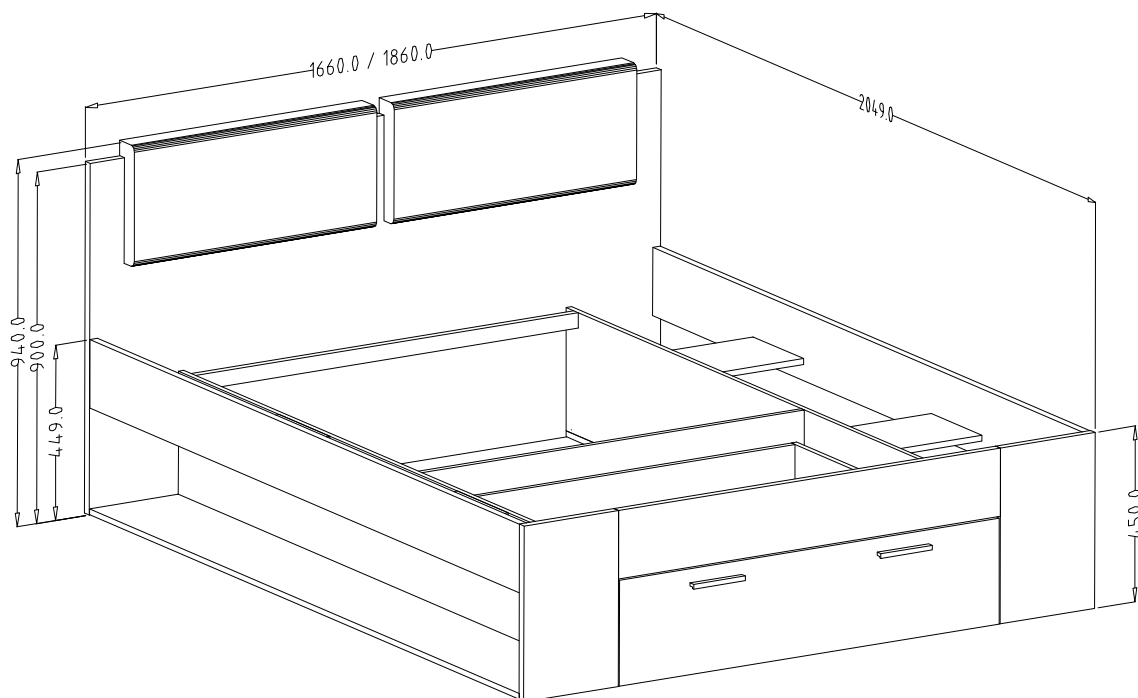
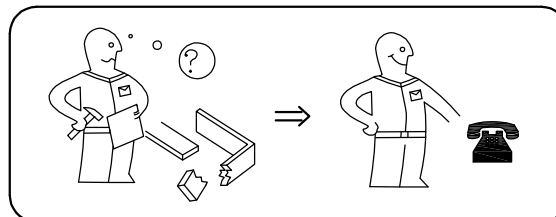
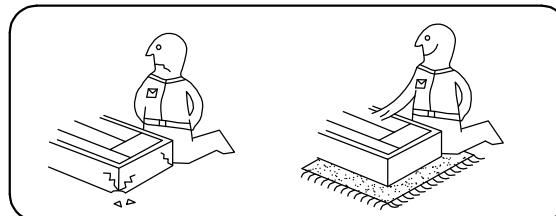

50/51/52

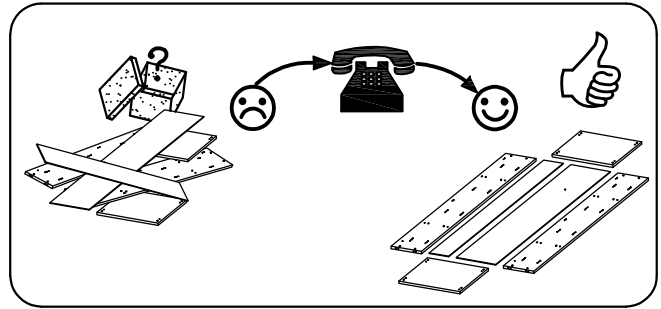
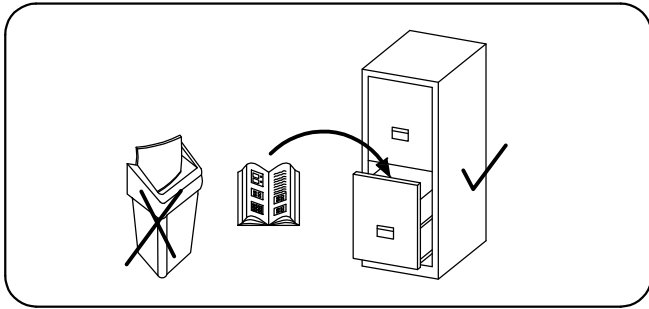

L - 1400 -

GY-990 GY-950 GY-969 GY-962 GY-929 GY-7490 GY-069 GY-190

L - 1600 -

GY-991 GY-951 GY-971 GY-963 GY-930 GY-7500 GY-070 GY-191

L - 1800 -

GY-992 GY-952 GY-972 GY-964 GY-931 GY-7510 GY-071 GY-192

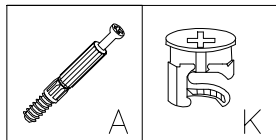
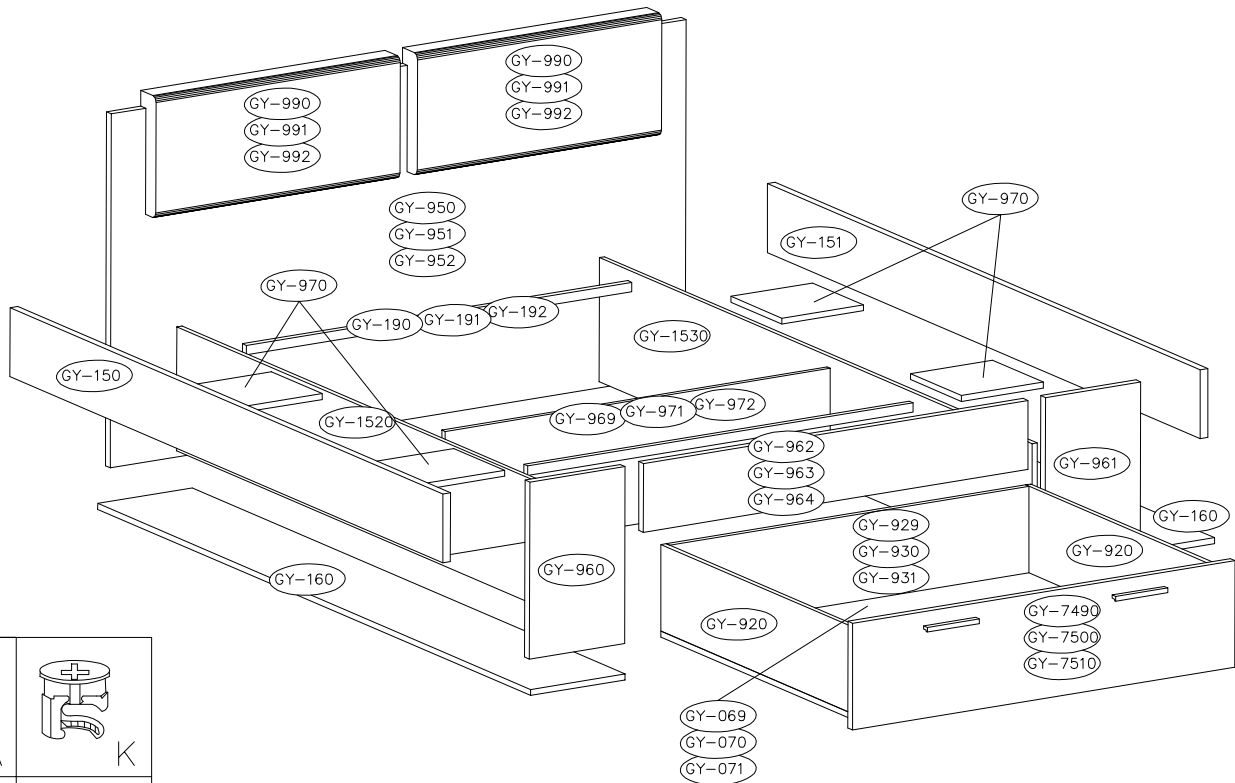



49

12

45	8	54	4	8	4	64	4	4	
4	12	4	8	1	4	8	2	1	12

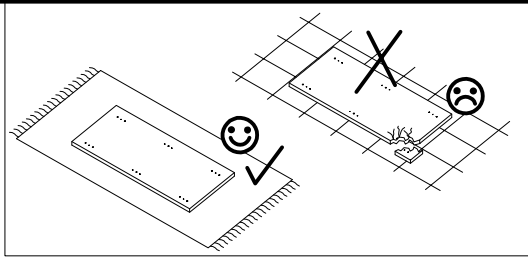



1

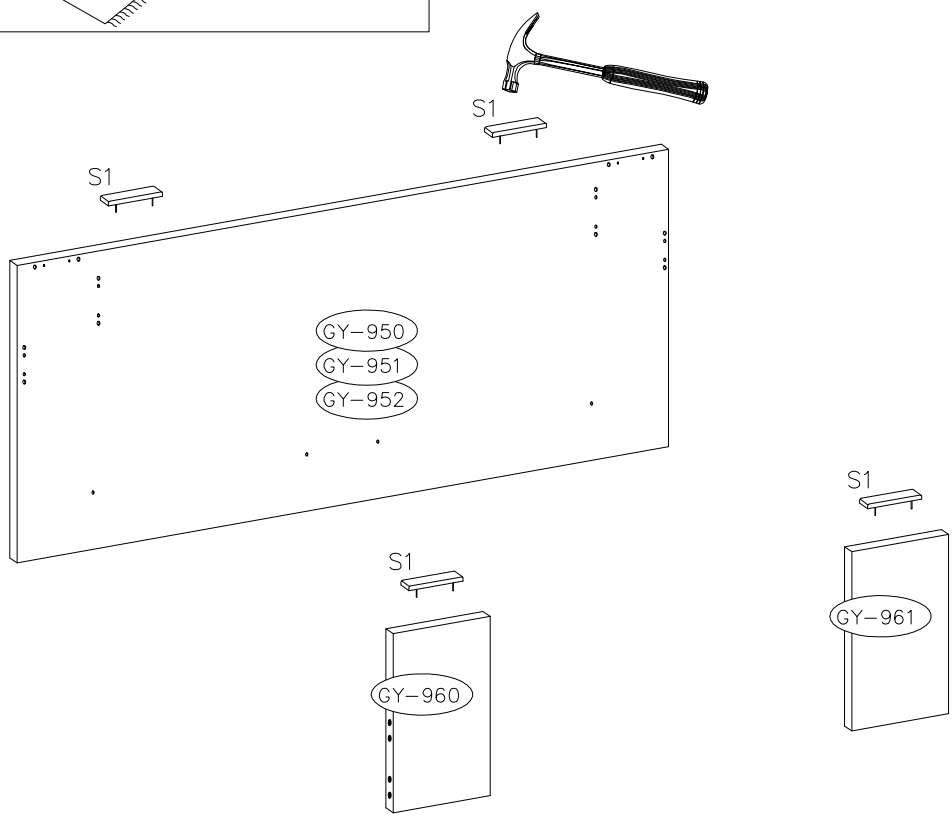

	S1
	4



2

			
K	D2	F2	I
8	4	4	1

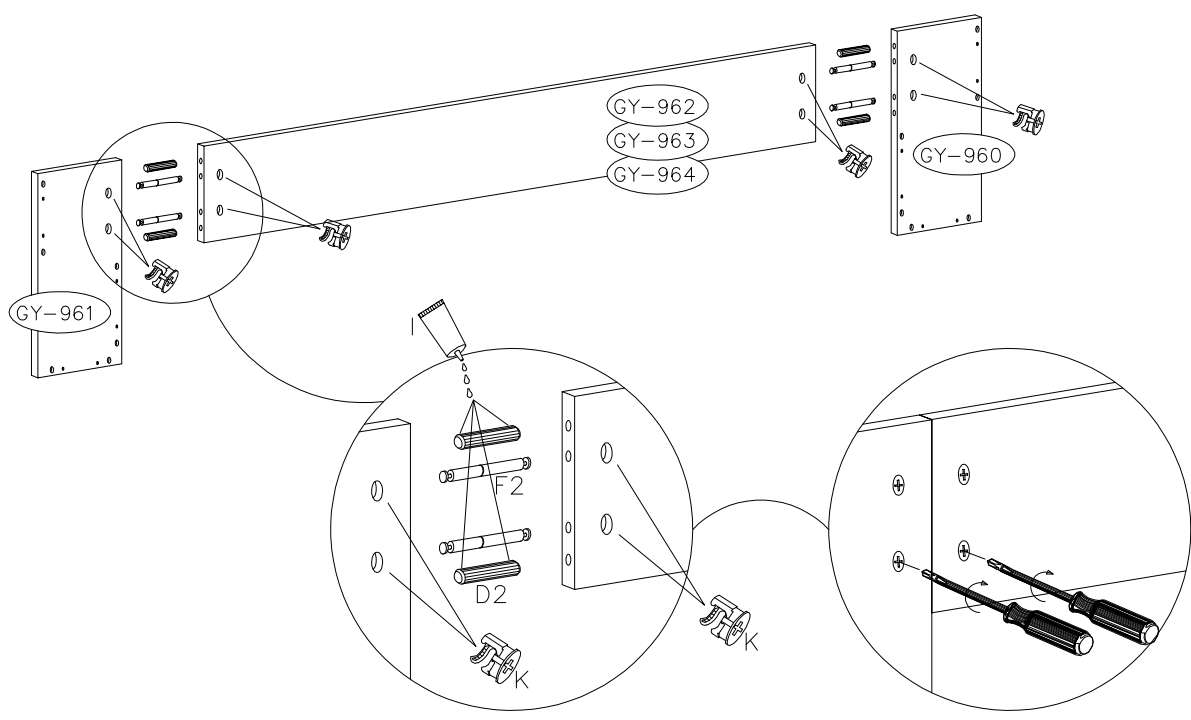

3



A

12

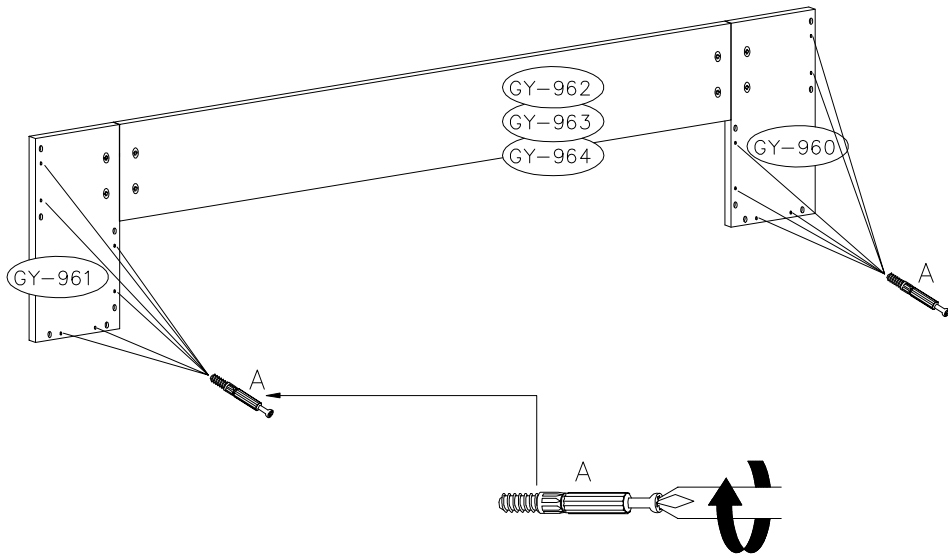

4







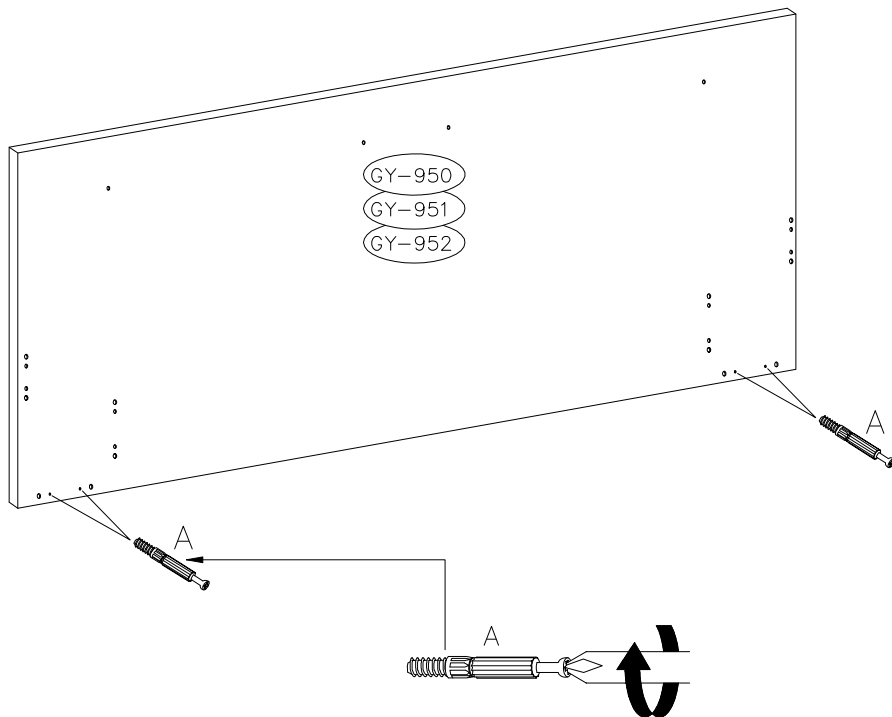

A

4



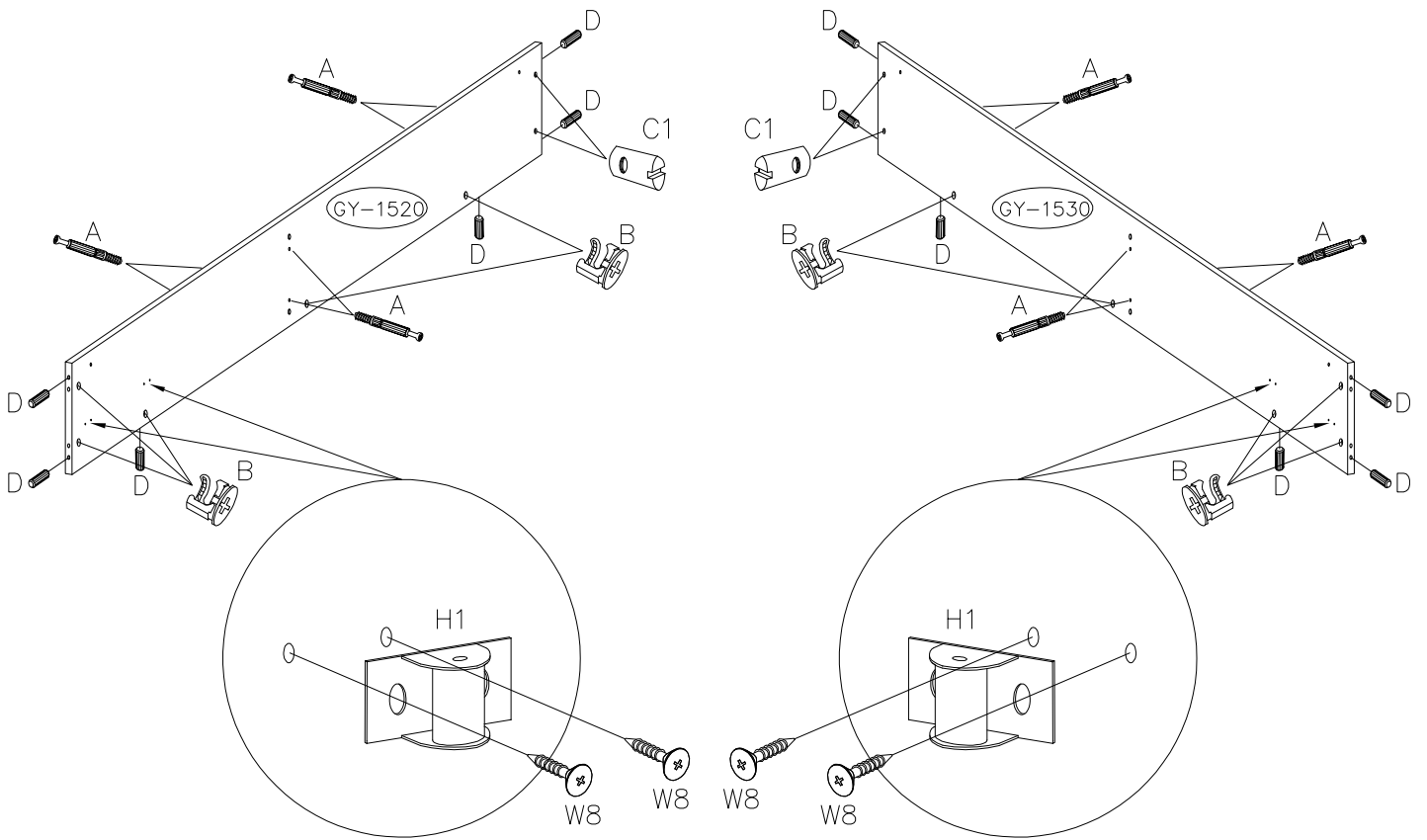

5

10X13  C1	 B	8.0X30  D	 A	3.5X13  W8	7.404  H1
4	10	12	12	8	4







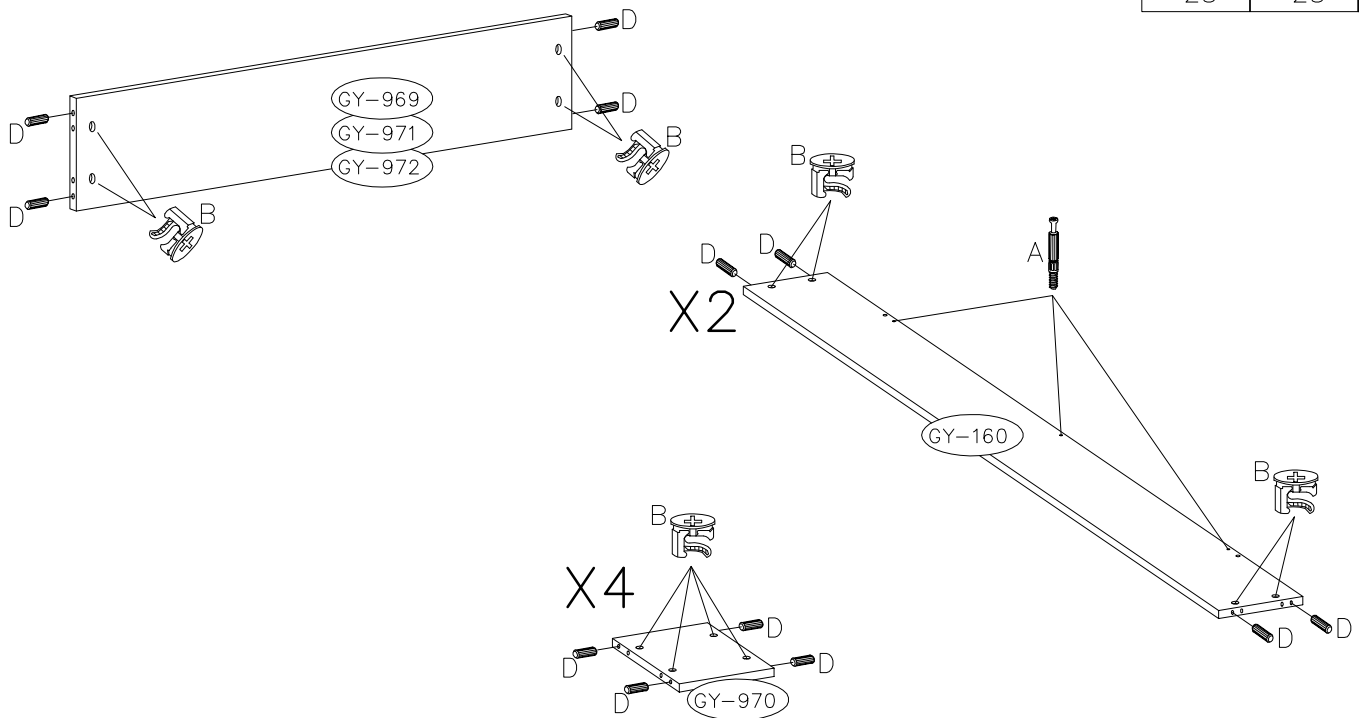

6

 B	8.0X30  D	 A
28	28	6



7

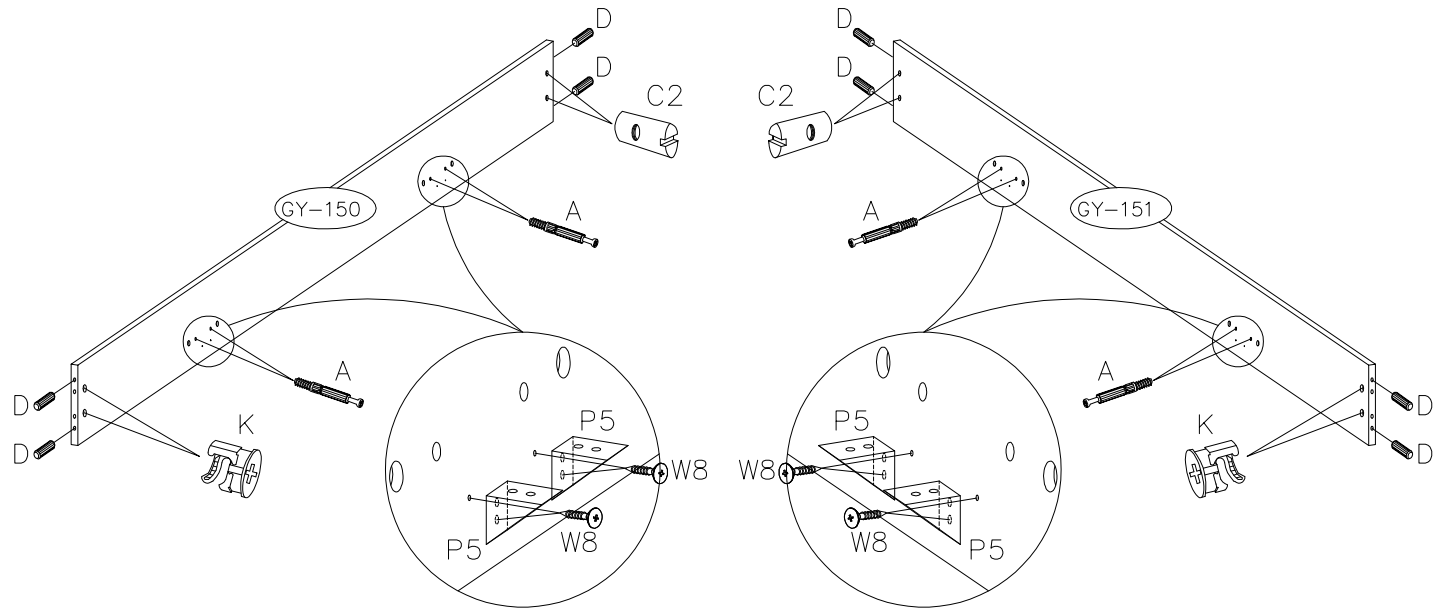

10X17  C2	 K	8.0X30  D	 A	3.5X13  W8	 P5
4	4	8	8	16	8

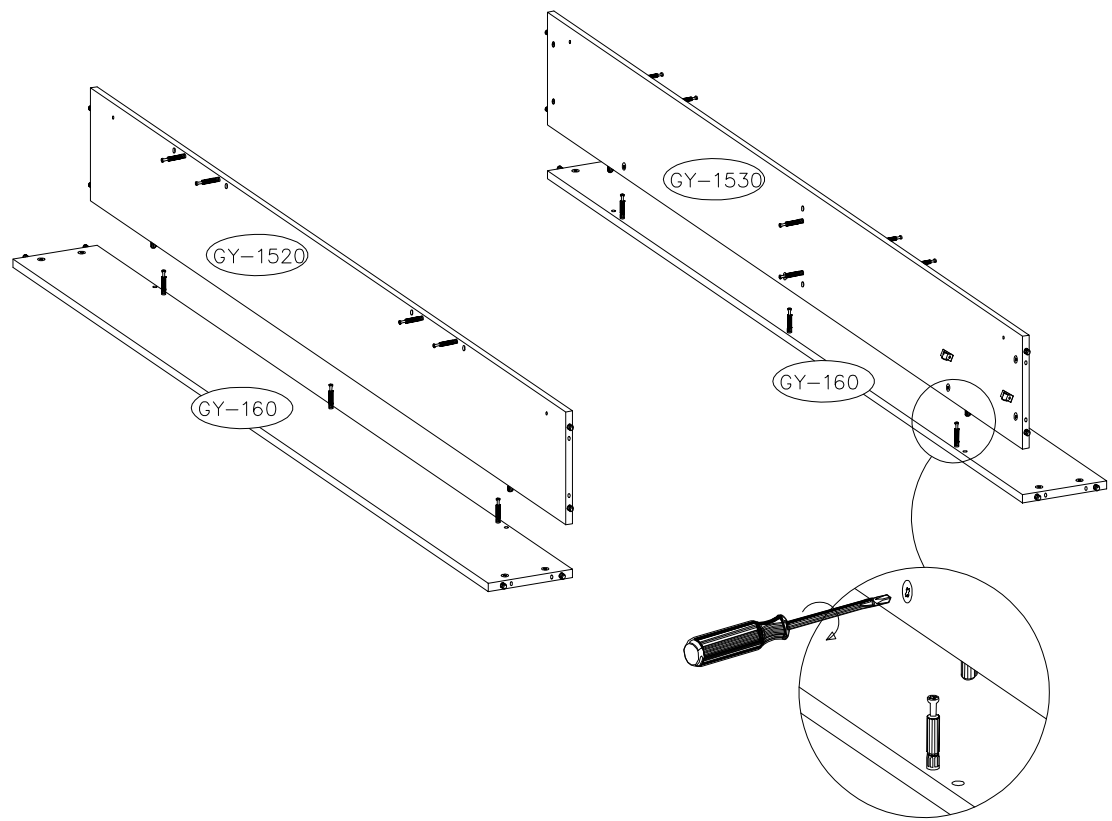

8



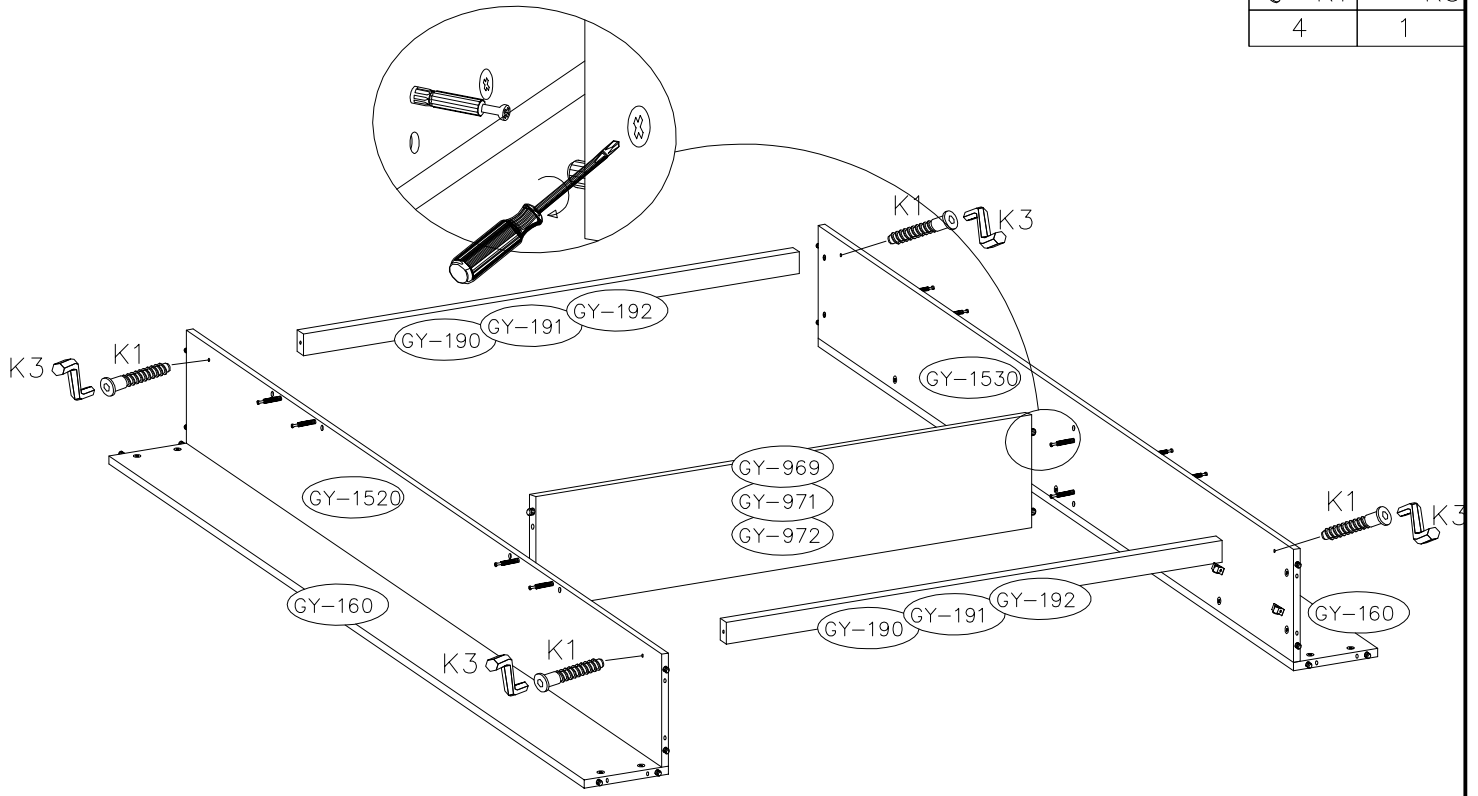

9

6.4X50  K1	4mm  K3
4	1



10

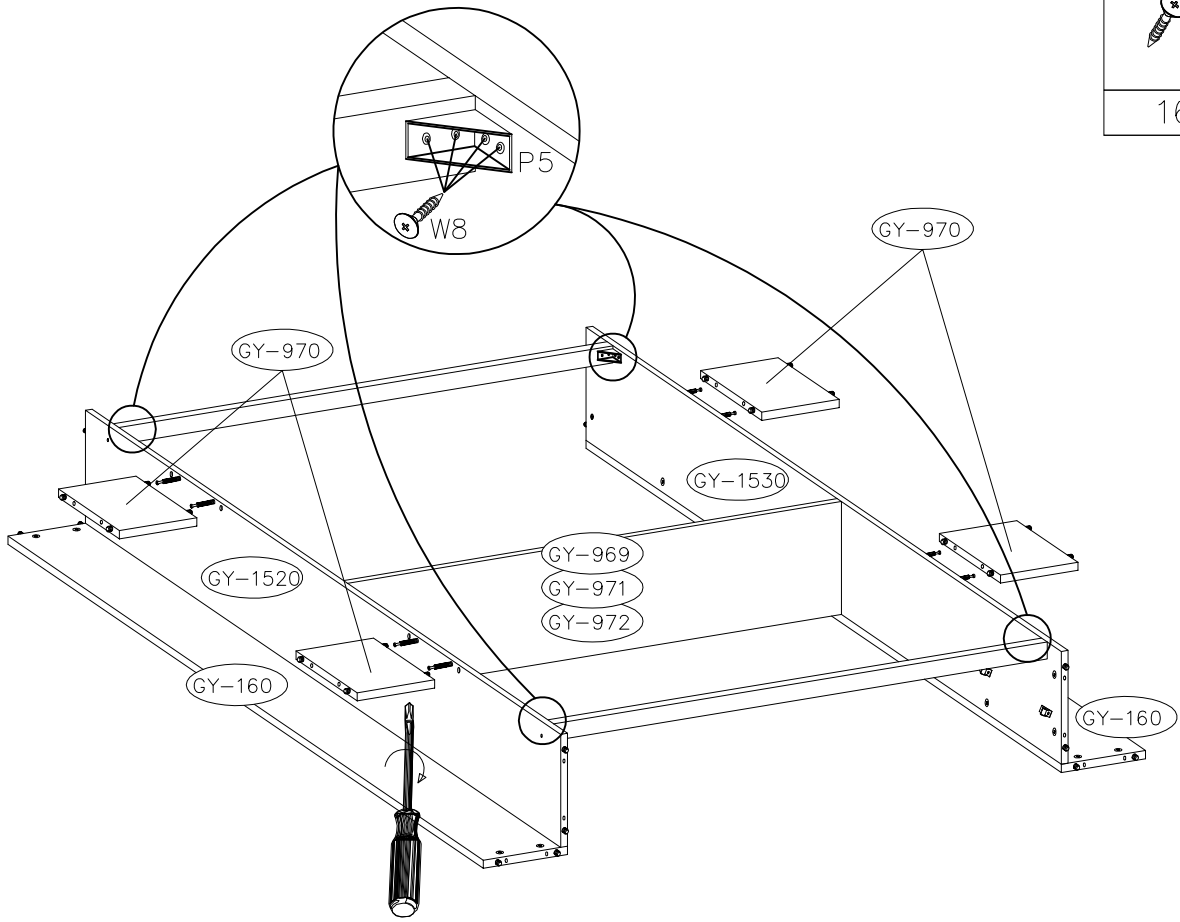

3.5X13  W8	 P5
16	4

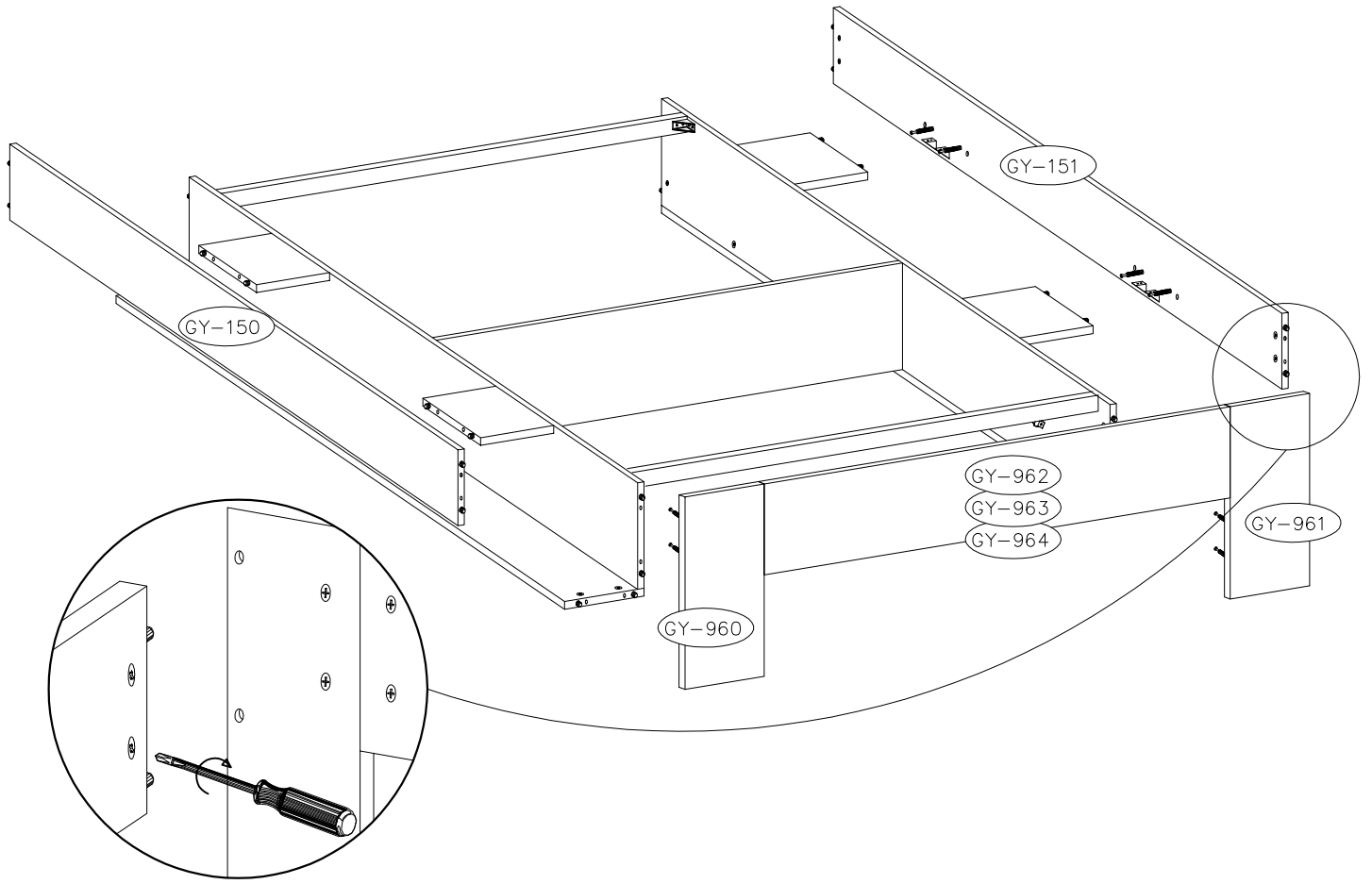

11





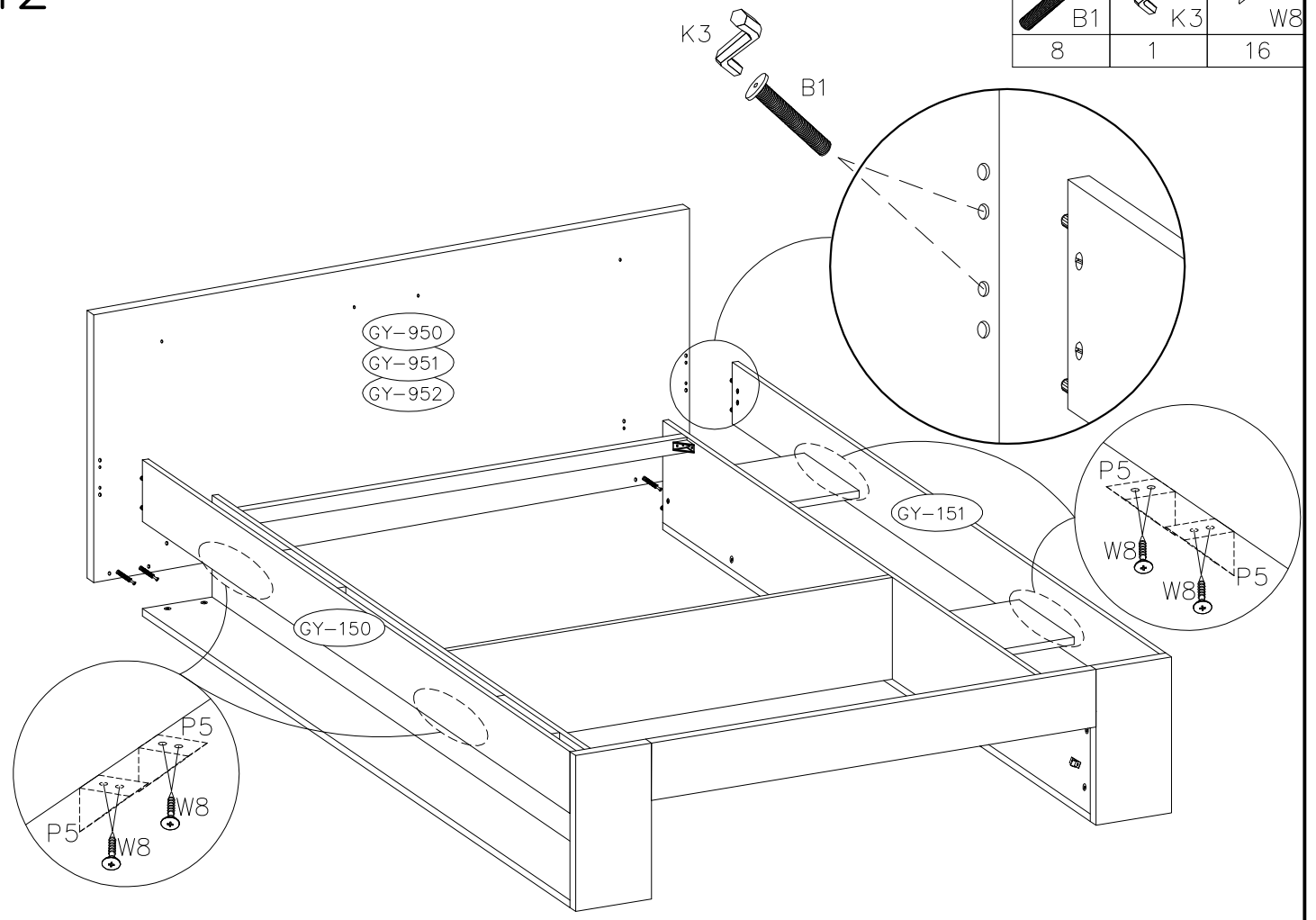

12

M6.0X55	4mm	3.5X13
 B1	 K3	 W8
8	1	16



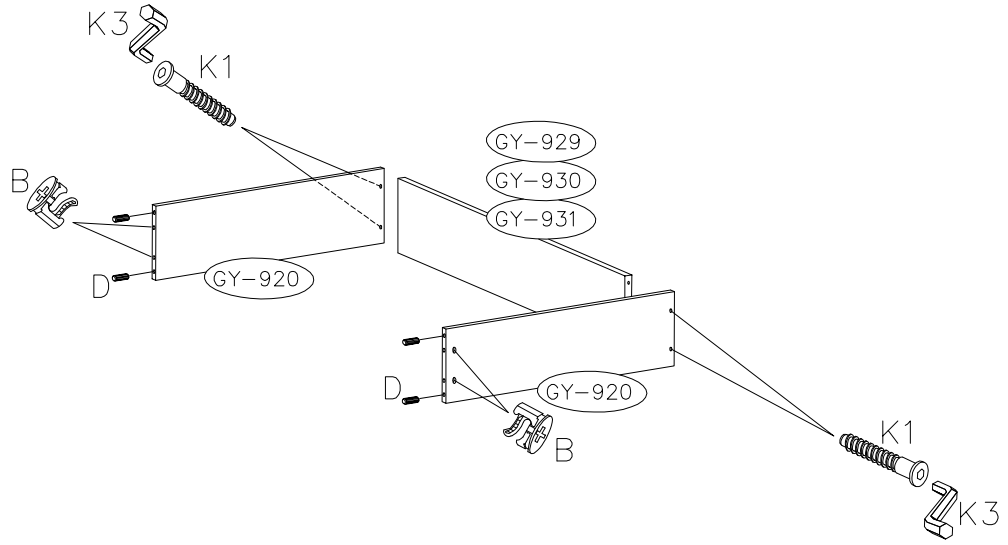

13

			
B	D	K1	K3
4	4	4	1



14

		
A	B	D
7	3	2

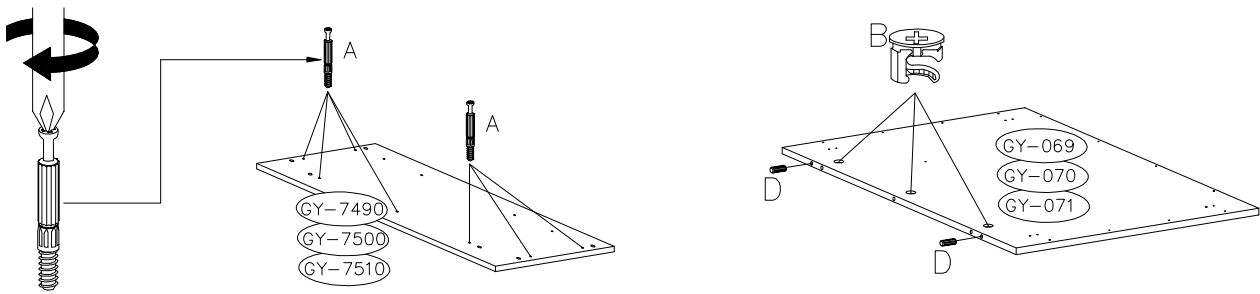

15

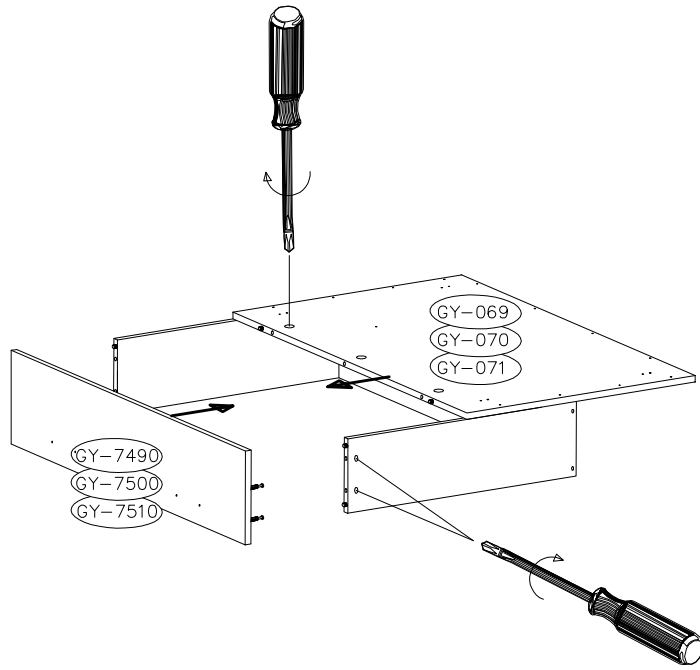

16

3.5X30





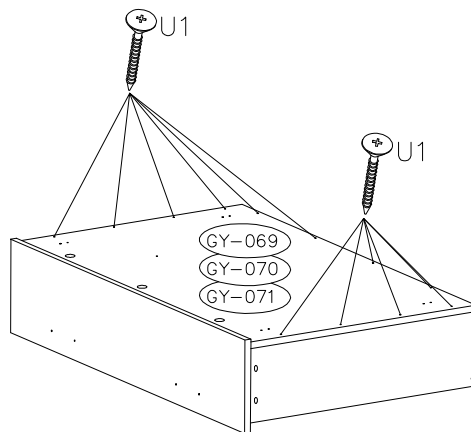

U1

12



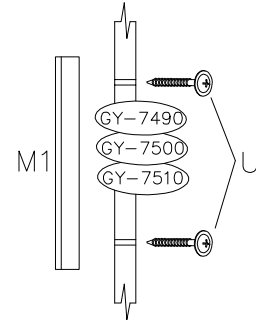
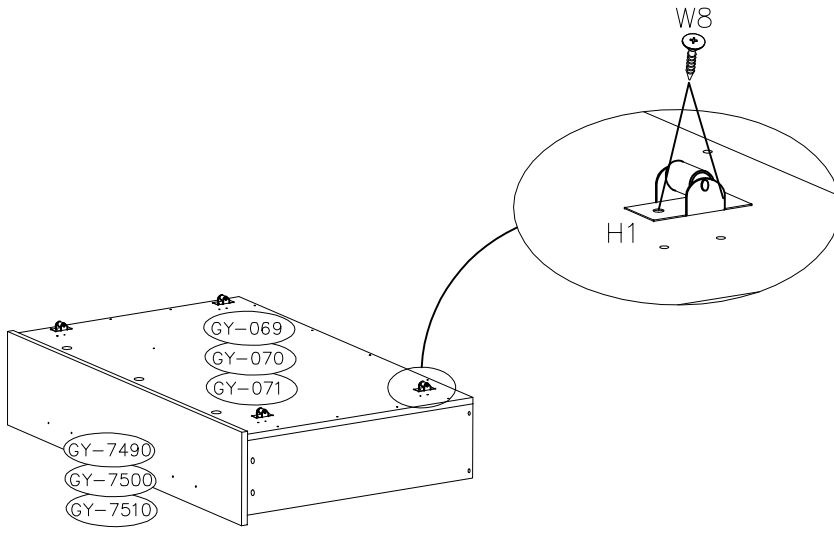

17

3.5X13  W8	7.404  H1	4.0X25  U	 M1
8	4	4	2



18

4mm  K3	M6.0X32  N1	 C
1	4	8

