

T  
13-IZ-20

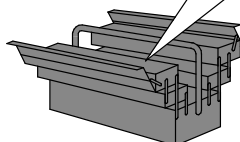

1

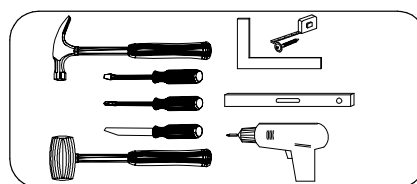
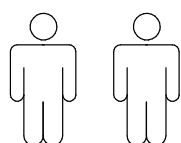
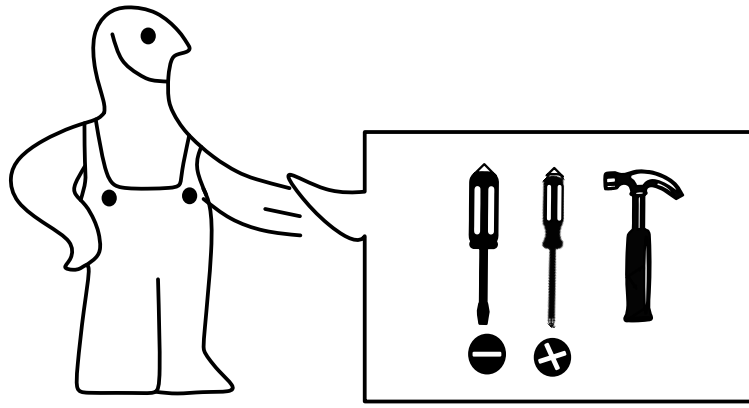

2

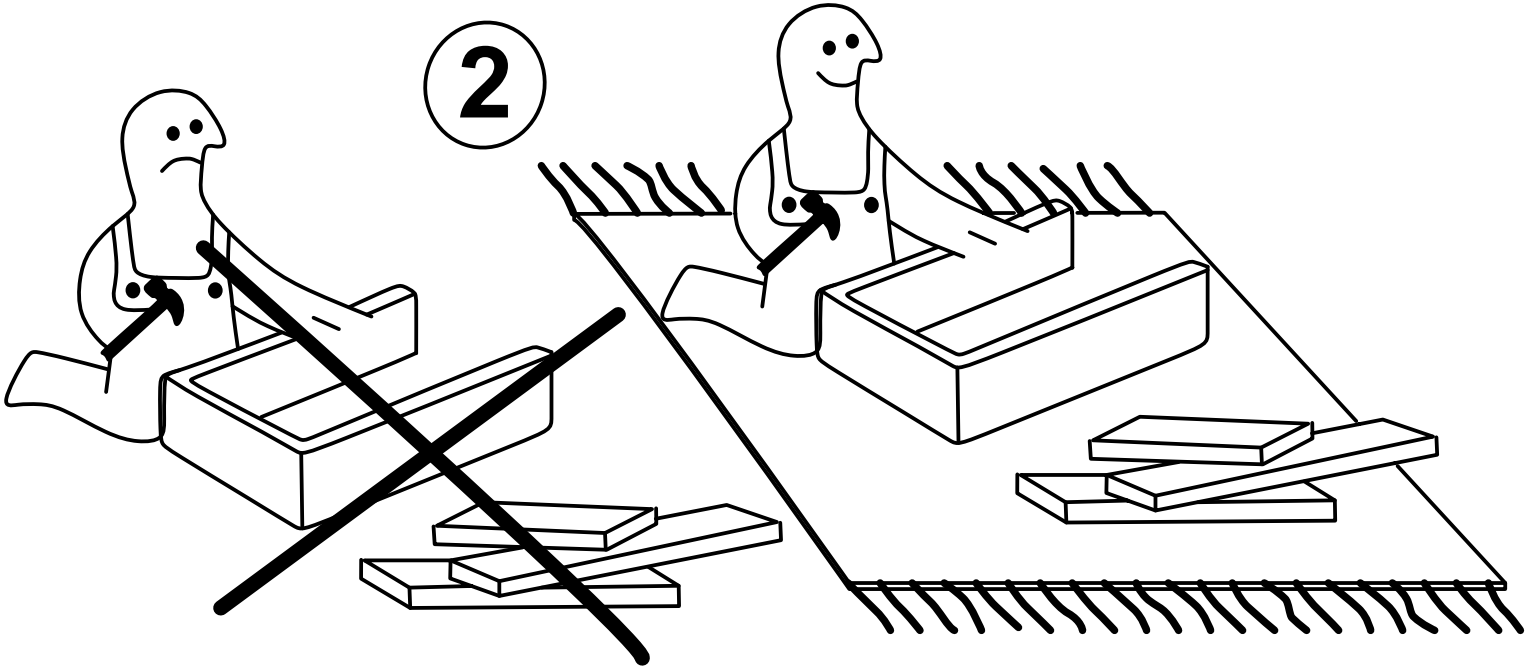

3



4

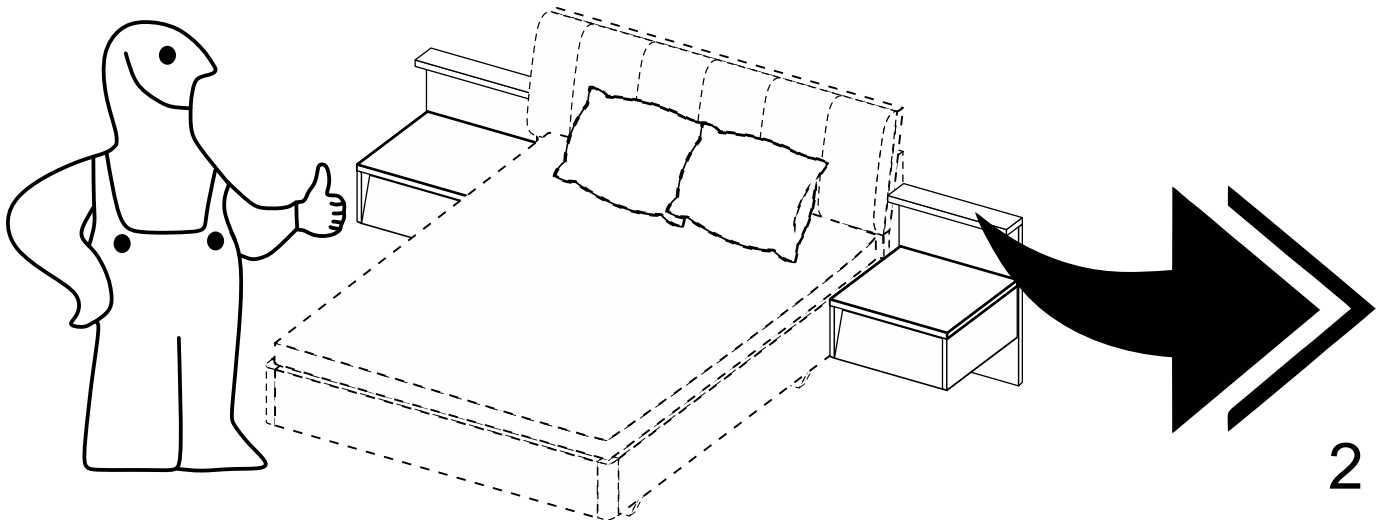

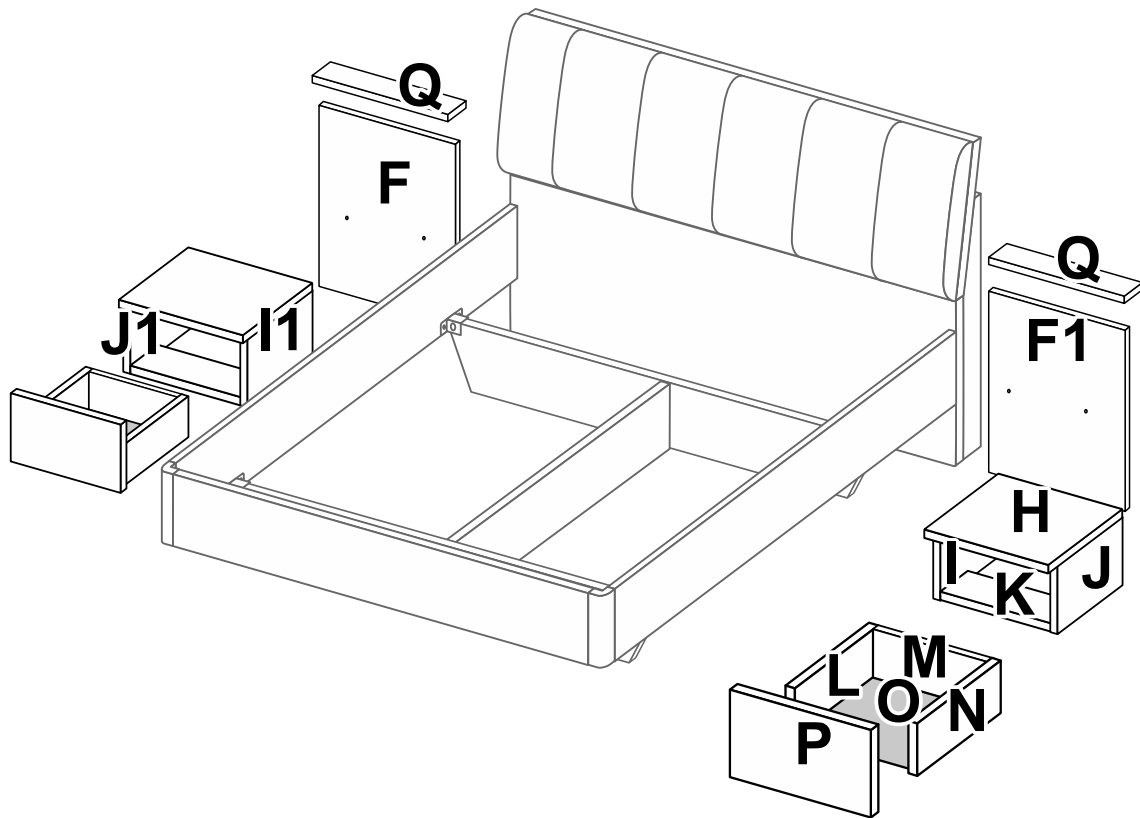

<b>F</b>	-	650	x	546	x	16	-	<b>x</b>	<b>1</b>
<b>F1</b>	-	650	x	546	x	16	-	<b>x</b>	<b>1</b>
<b>G</b>	-	1260	x	270	x	16	-	<b>x</b>	<b>1</b>
<b>H</b>	-	544	x	381	x	16	-	<b>x</b>	<b>2</b>
<b>I/I1</b>	-	192	x	380	x	16	-	<b>x</b>	<b>1</b>
<b>J/J1</b>	-	192	x	380	x	16	-	<b>x</b>	<b>1</b>
<b>K</b>	-	511	x	100	x	16	-	<b>x</b>	<b>2</b>
<b>L</b>	-	330	x	130	x	16	-	<b>x</b>	<b>2</b>
<b>M</b>	-	453	x	130	x	16	-	<b>x</b>	<b>2</b>
<b>N</b>	-	330	x	130	x	16	-	<b>x</b>	<b>2</b>
<b>O</b>	-	465	x	323	x	3	-	<b>x</b>	<b>2</b>
<b>P</b>	-	505	x	181	x	16	-	<b>x</b>	<b>2</b>
<b>Q</b>	-	546	x	110	x	16	-	<b>x</b>	<b>2</b>

