

A1 X8 ø8x36	B11 X4 Ø7x50	G4 X4	B4 X4	B5 X4 ø15x12	G5 X4
G7 X4	G20 X2	E1 X4 H=0	E2 X4 H=0	KL X2	UP6 X4 UPØ4x30
Z2 X4 ø5	S1 X6	I11 X4	D10 X8 USØ3,5x13	D11 X4 USØ3,5x25	G2 X1

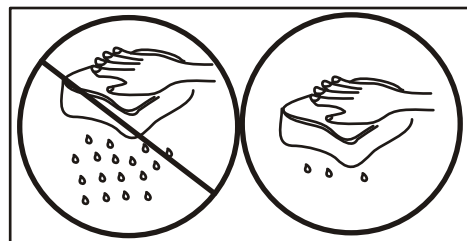

1

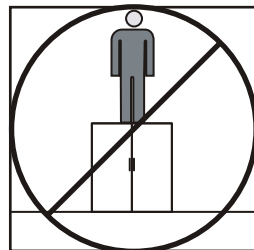
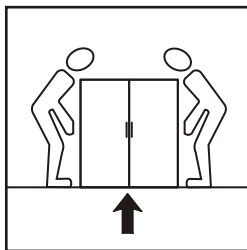
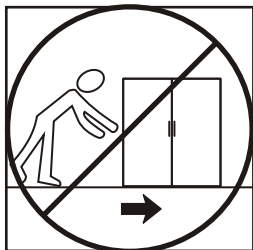
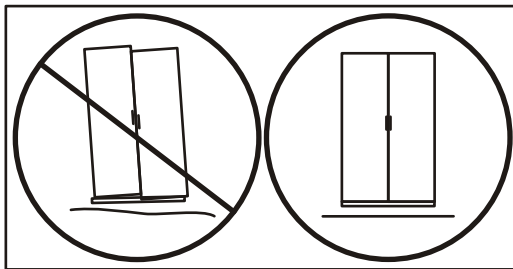
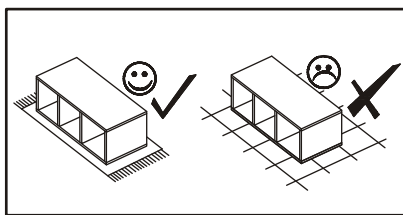
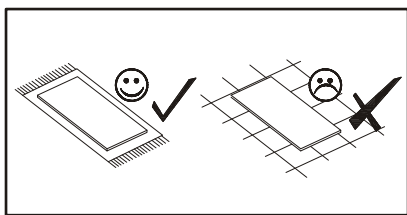
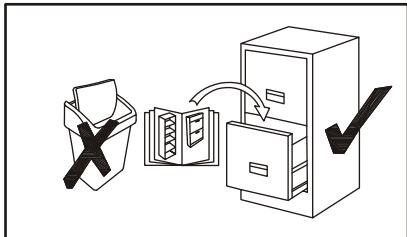
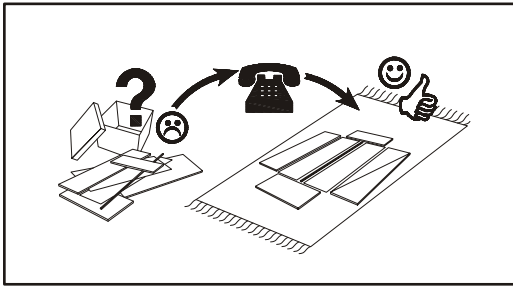
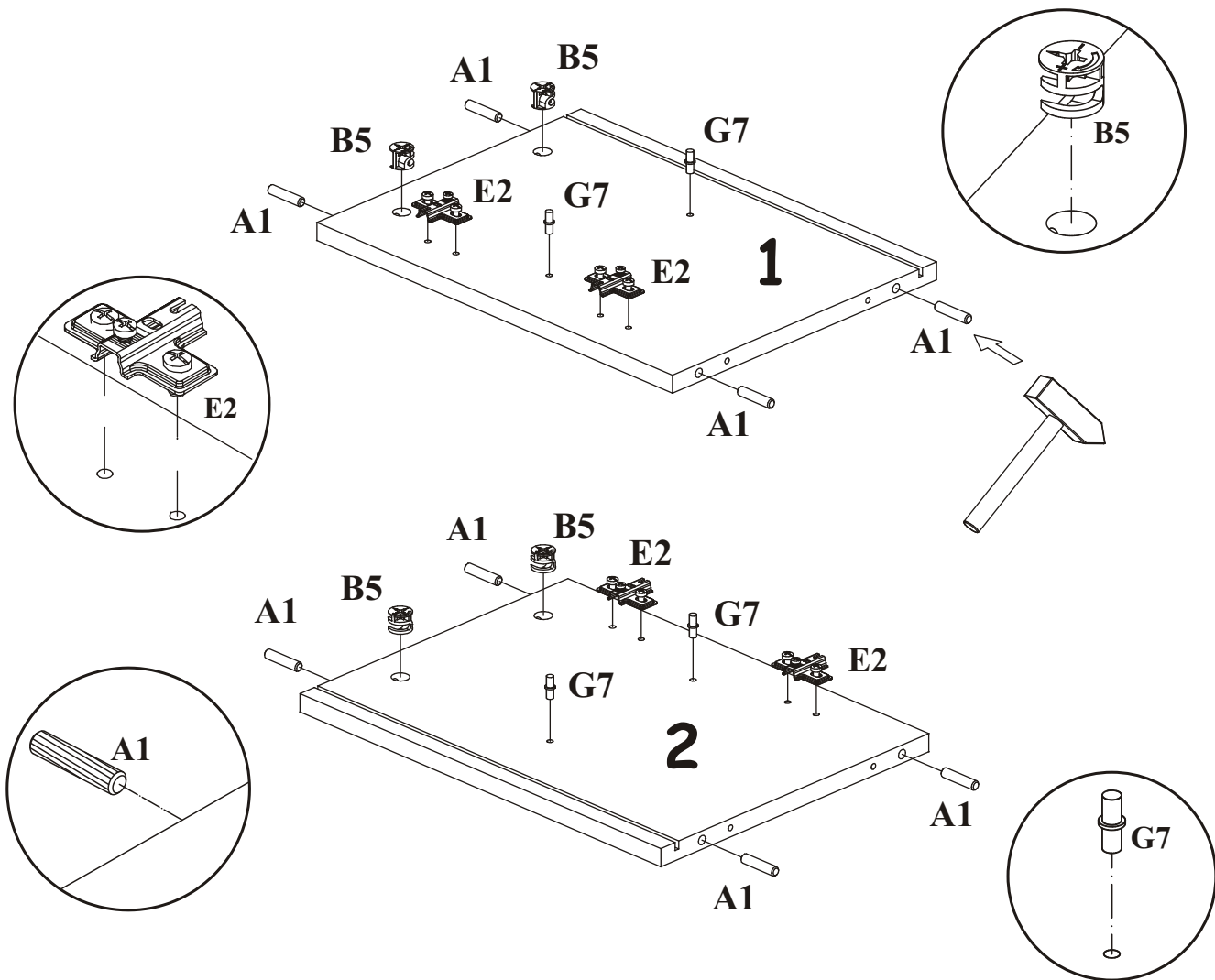

2

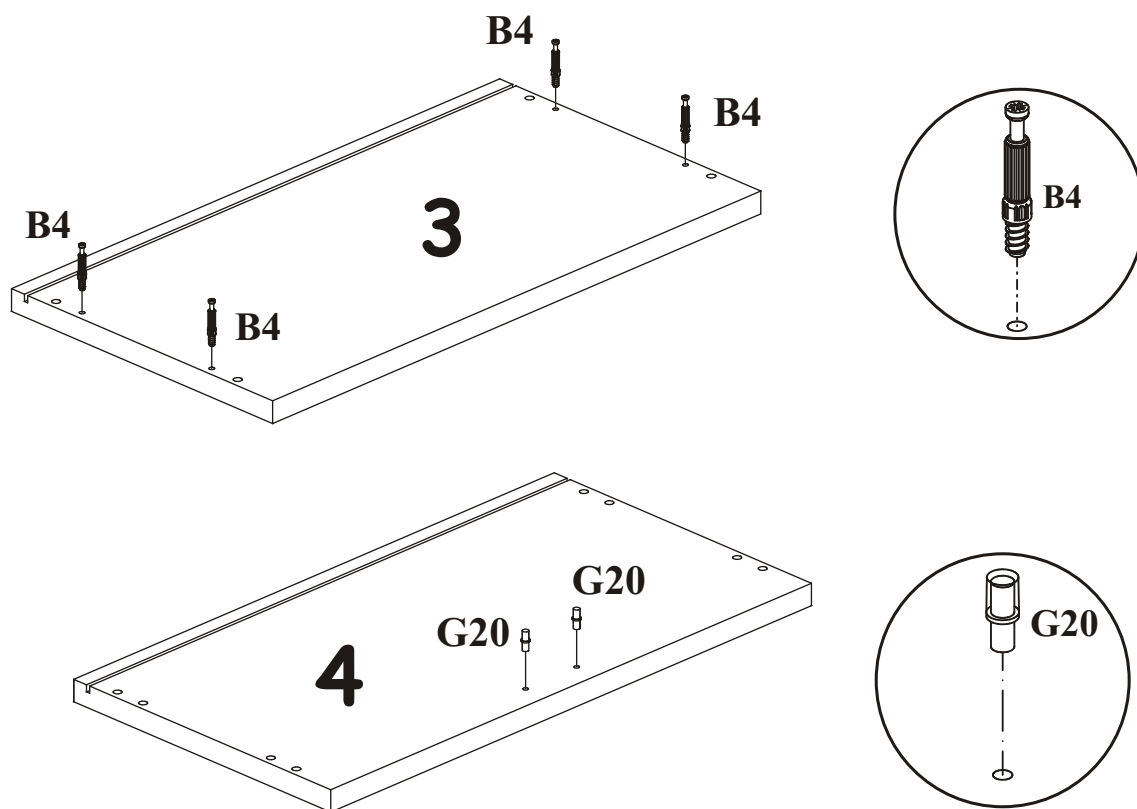

3

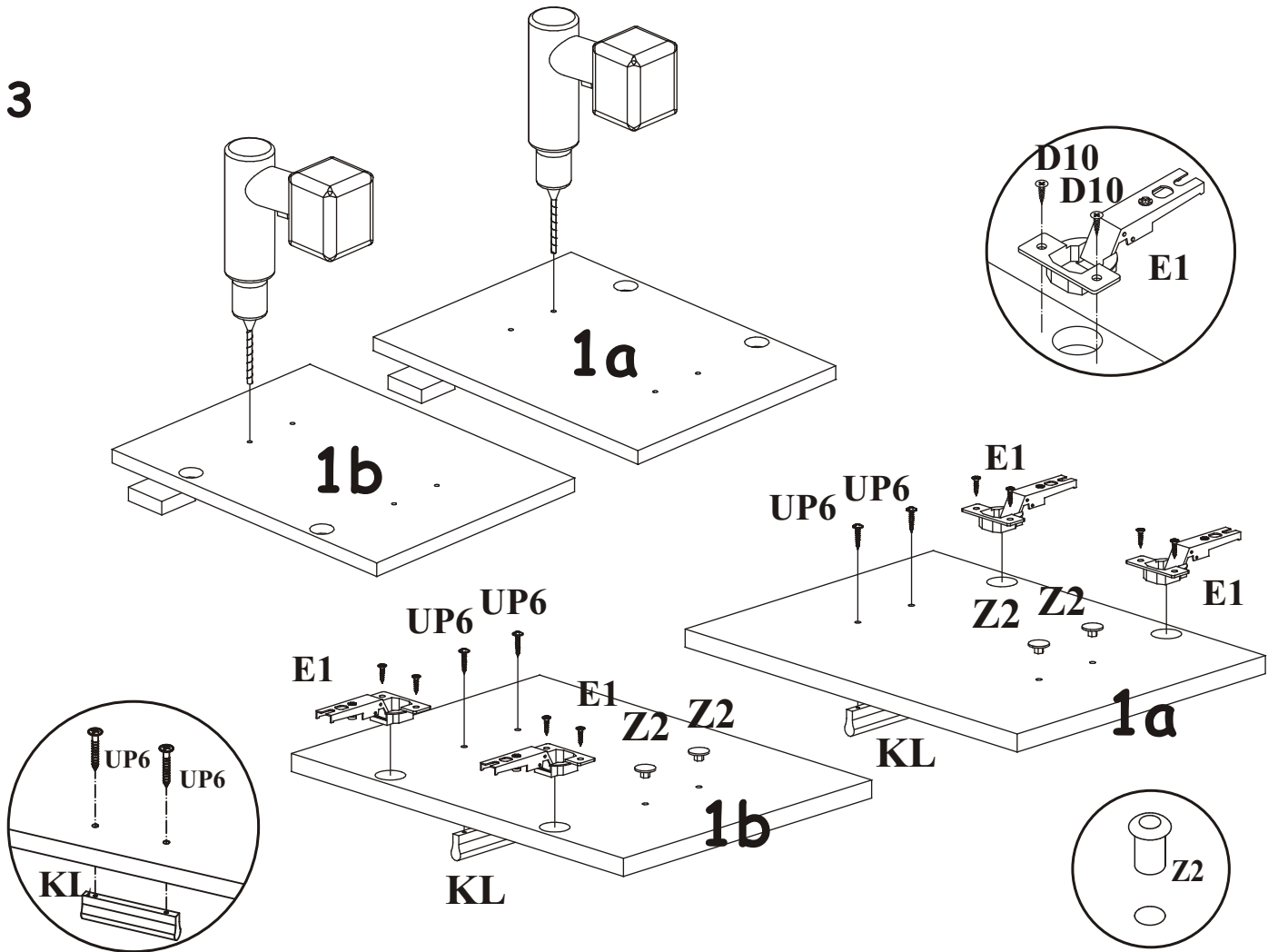

4

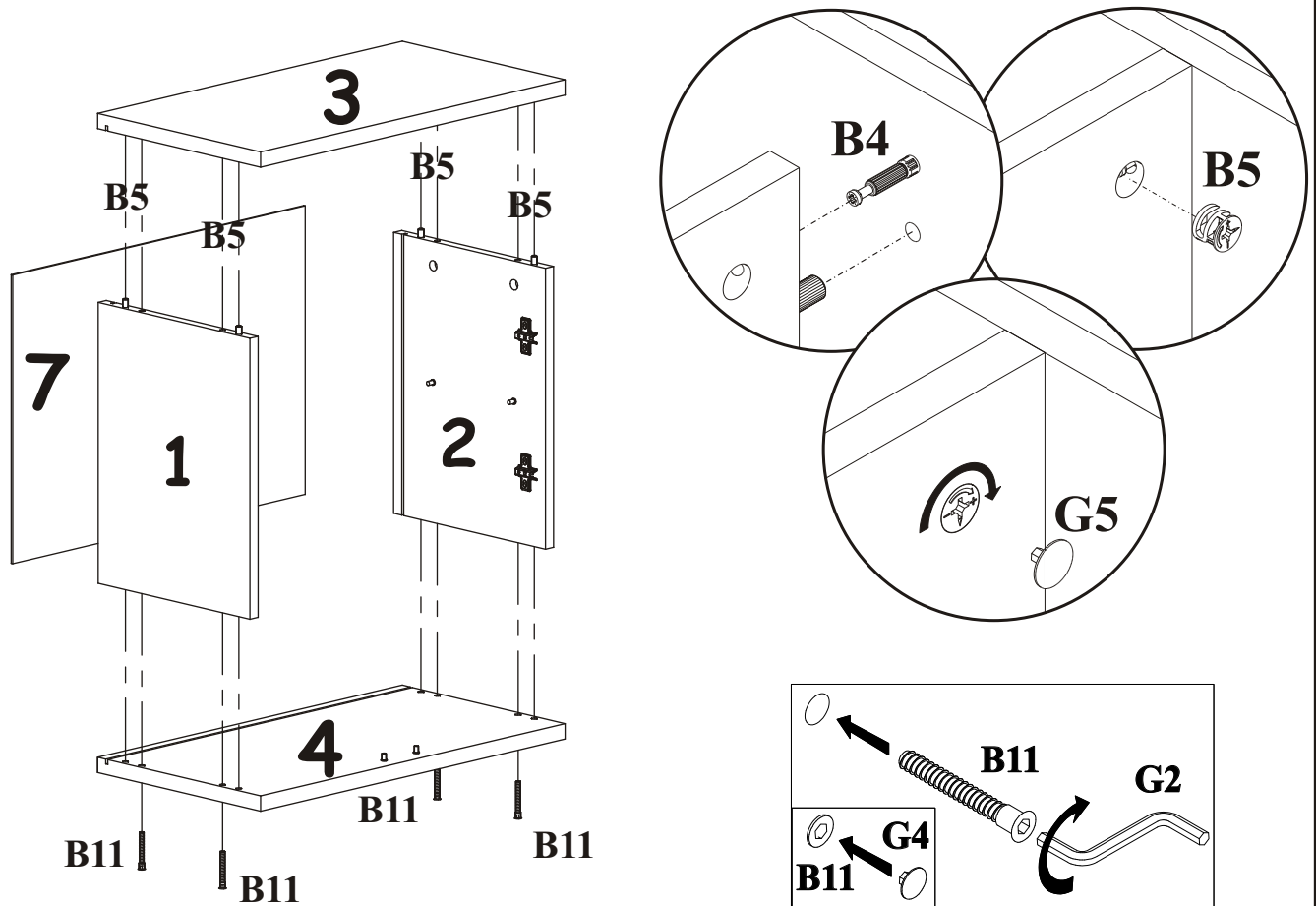

5

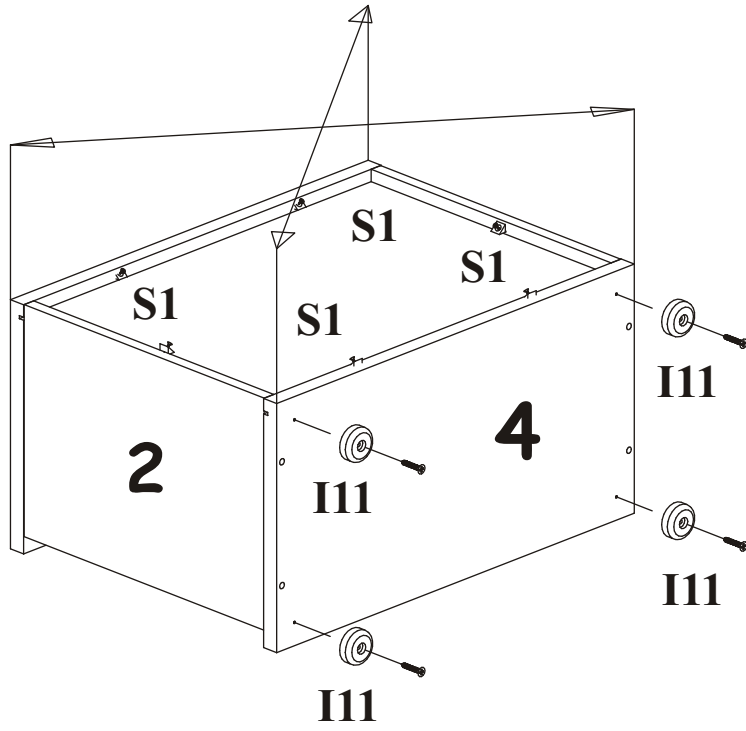

X=Y 90°

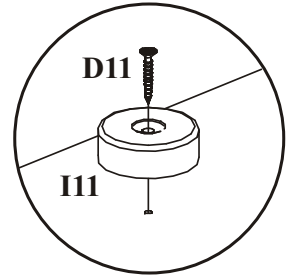
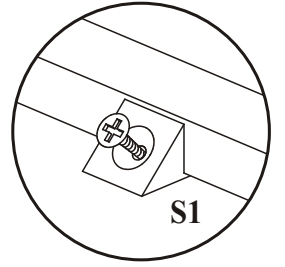

6

