



















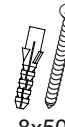

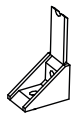
A0  Ø8x30 x18	B0  x8	B1  Ø7x50 x8	C0  x10	C1  16 mm x10	C2  x10	D0  3x15 x14	D10  4x16 x8	D17  3.5x16 x12	D32  6x30 x5	E4  8x50 x2	F0  x14
F1  x4	F2  x5	G1A  x4	G1B  x4	H0  x4	I1  x2	T21  x5	U0  x4	Z  4mm x1	Z1  6mm x1		

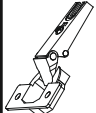



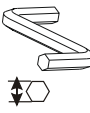
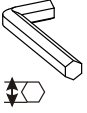
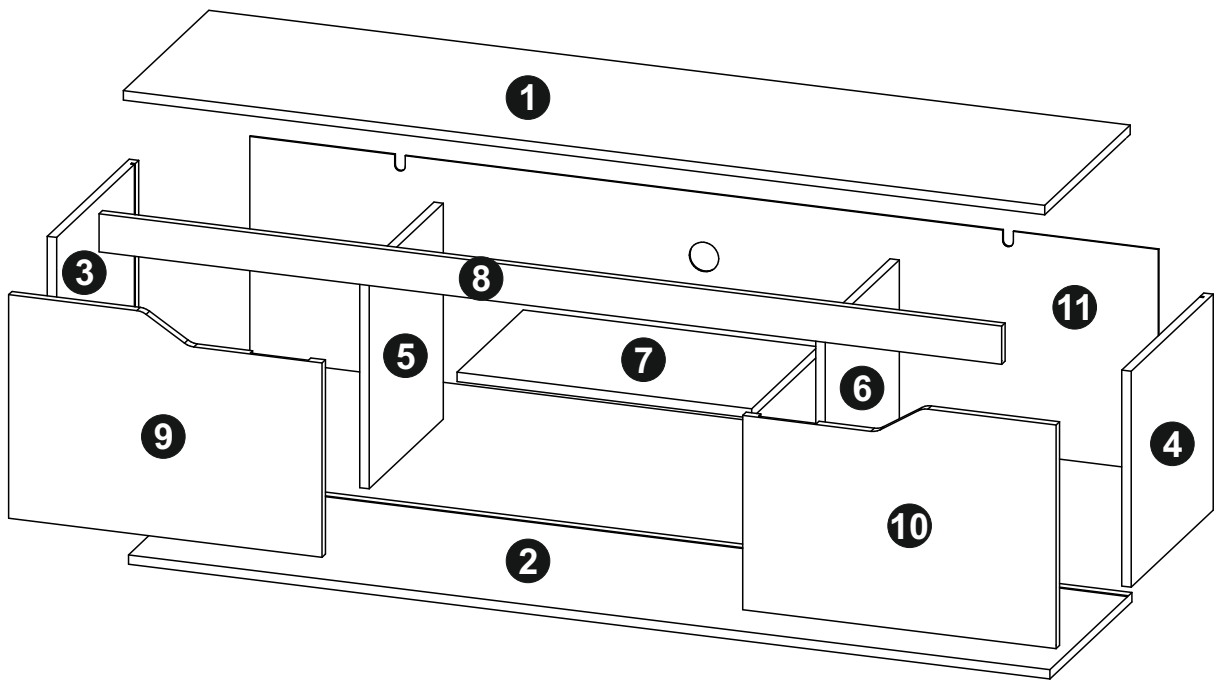

1	1570x400	1
2	1570x400	1
3	368x384	1
4	368x384	1
5	368x347	1
6	368x347	1

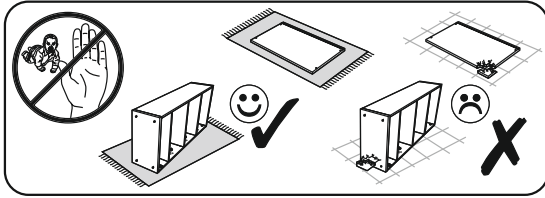
7	501x310	1
8	1536x65	1
9	534x381	1
10	534x381	1
11	1548x378	1



1



A0  Ø8x30 x10	C1  16 mm x6	C2  3.5x16 x10	D17  3.5x16 x4	G1B  x4	I1  x2
---	--	--	--	--	---

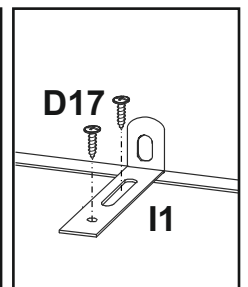
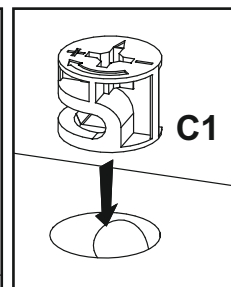
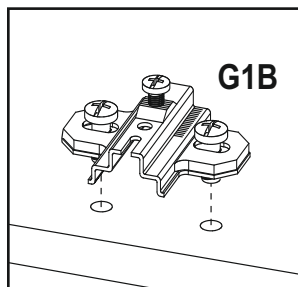
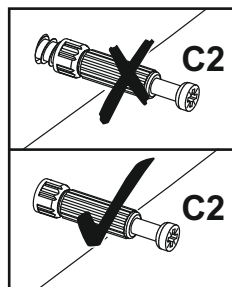
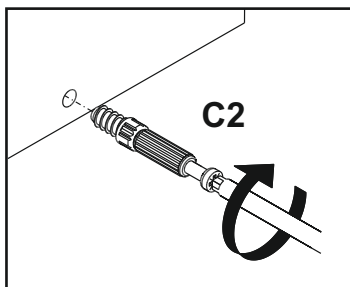
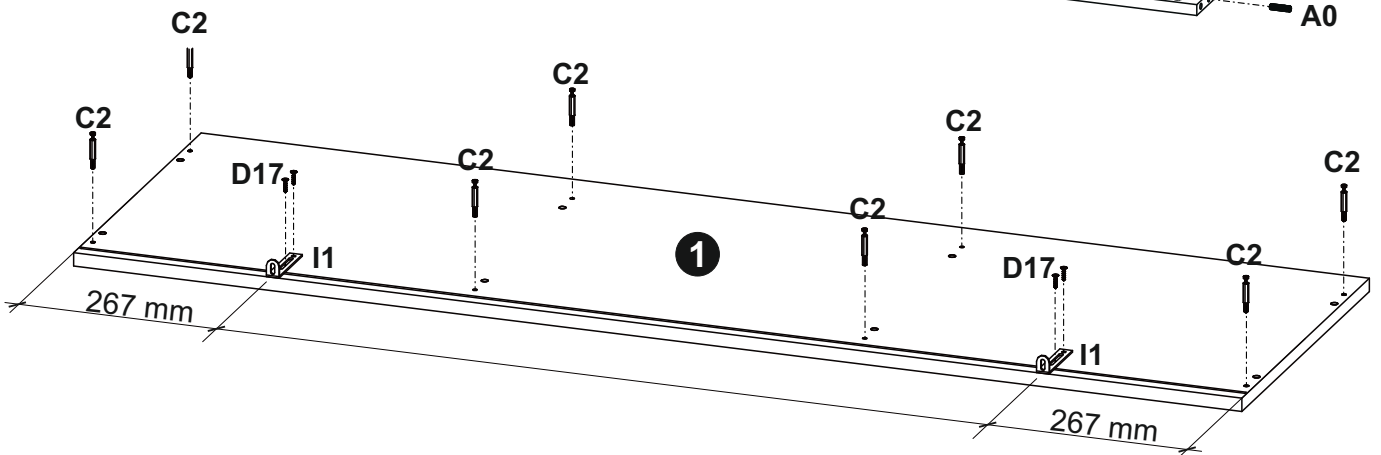
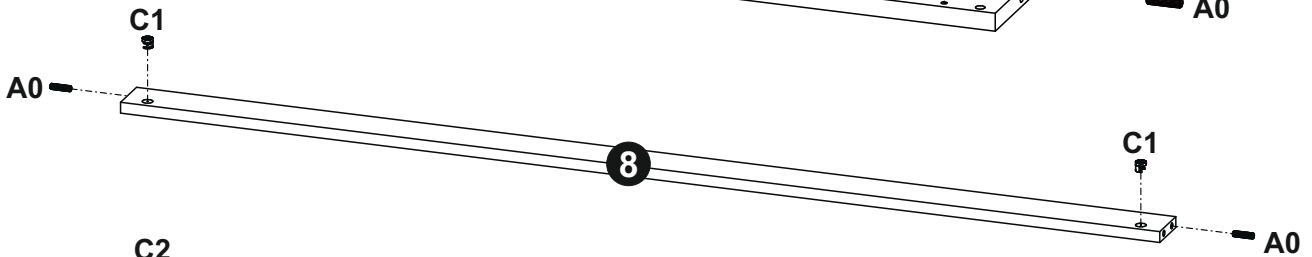
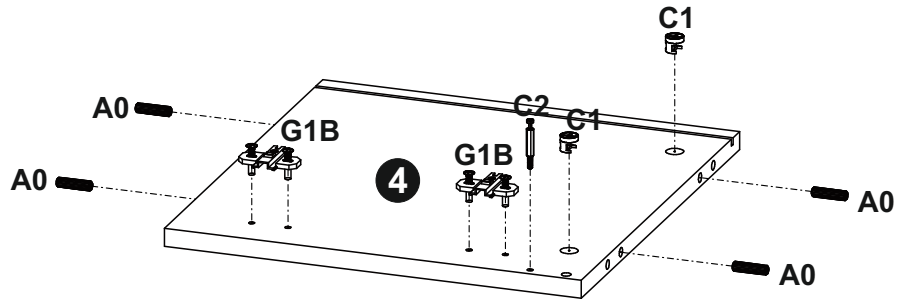
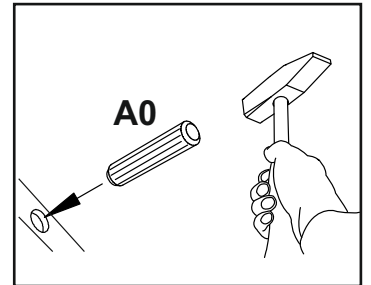
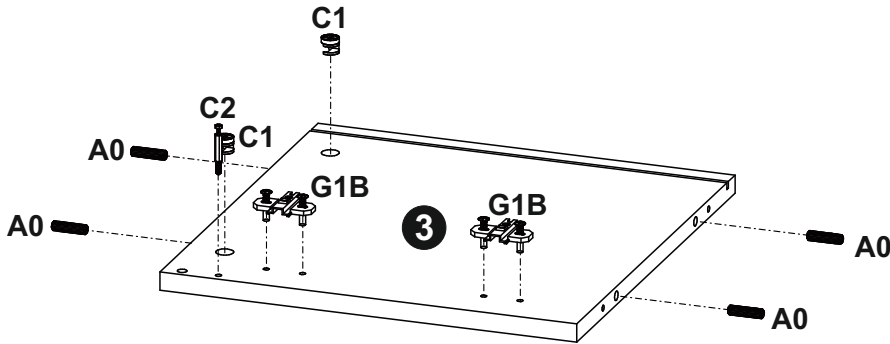

3

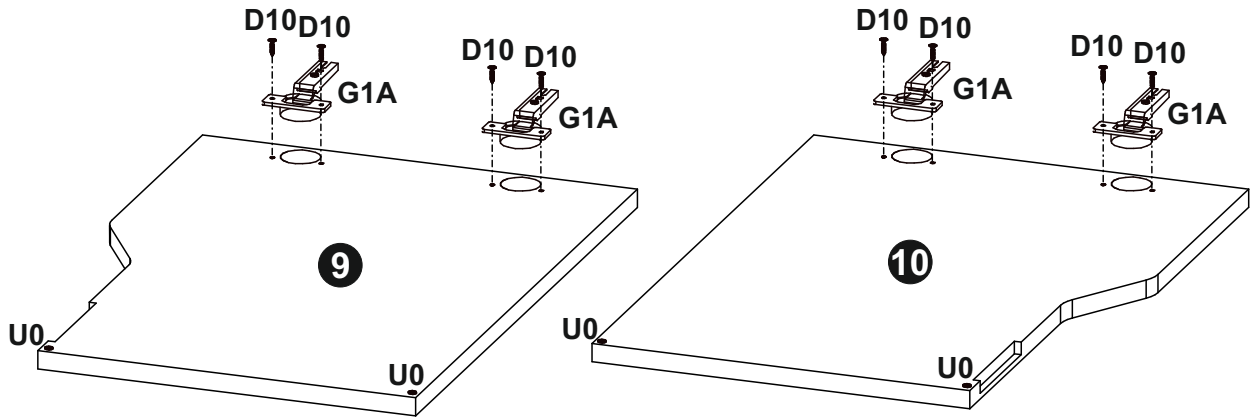
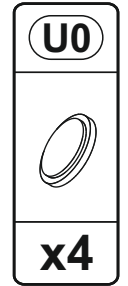
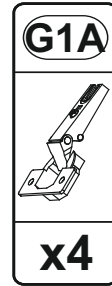
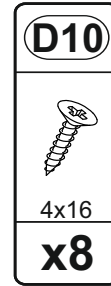
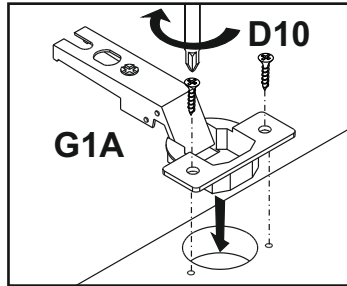
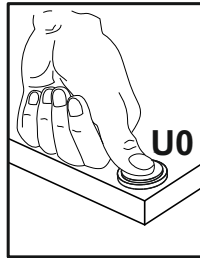
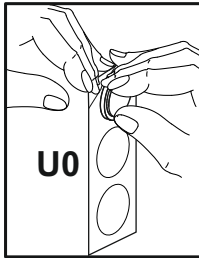

4

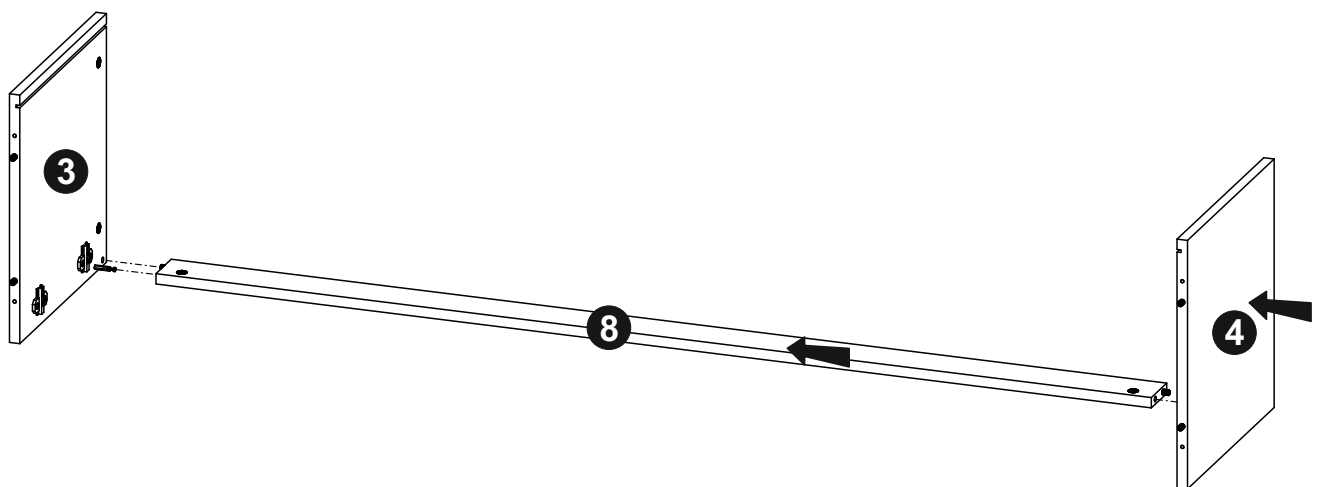
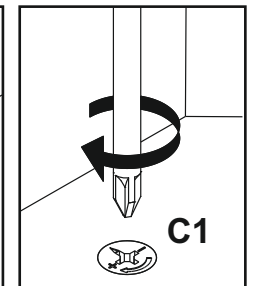
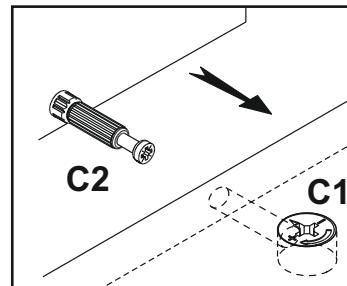

5

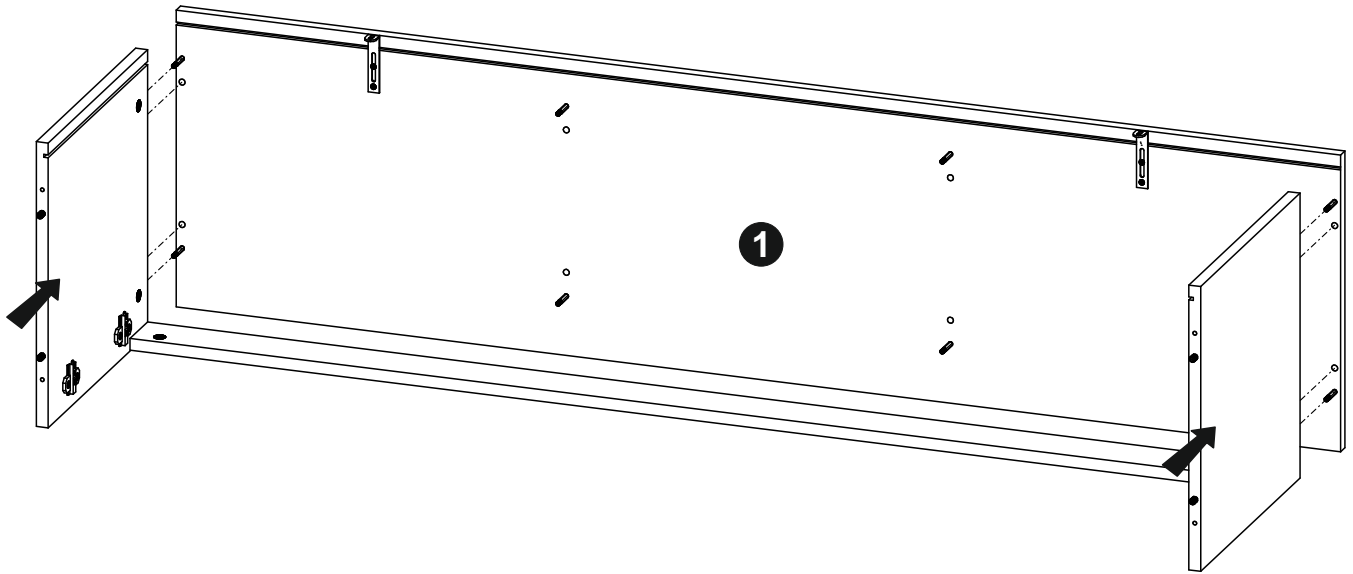
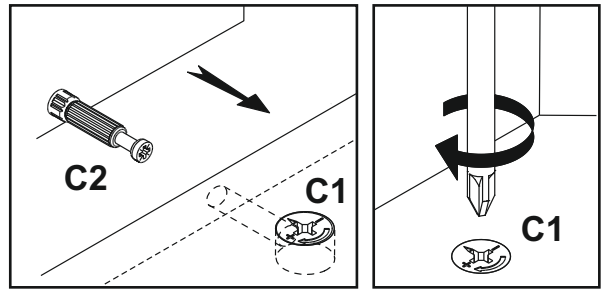

6

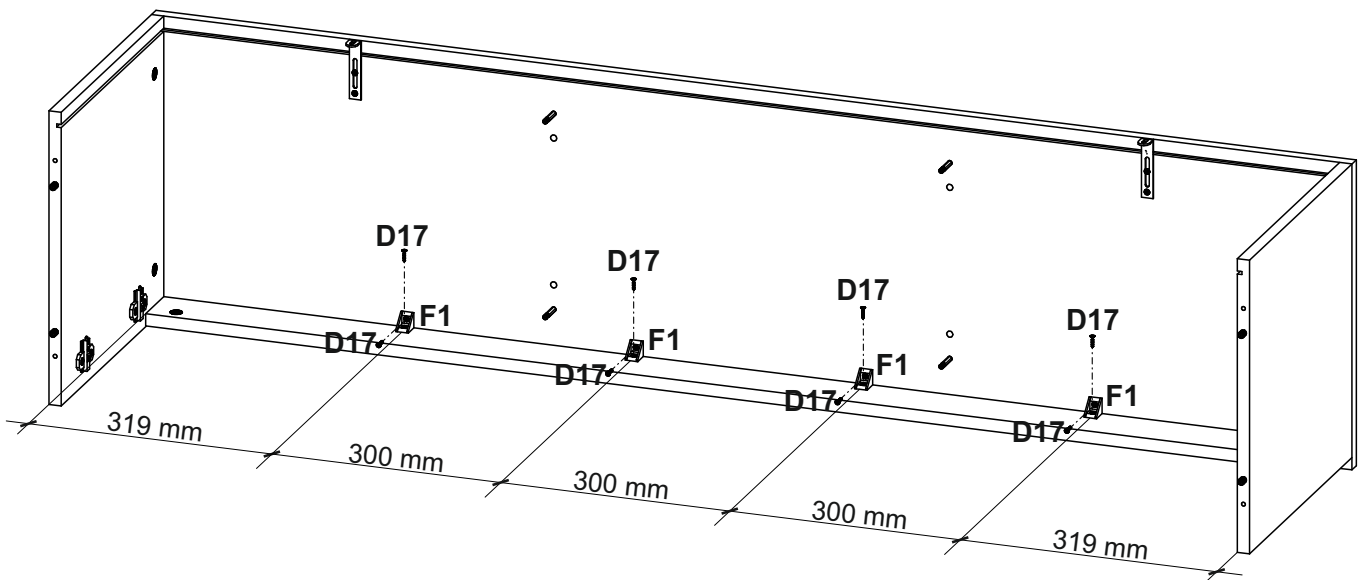
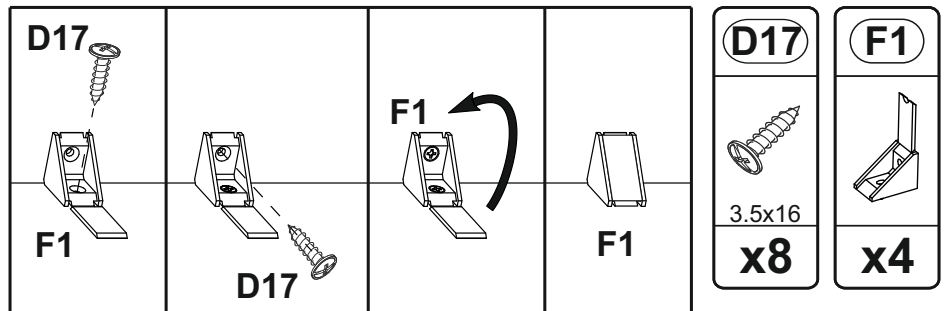

7

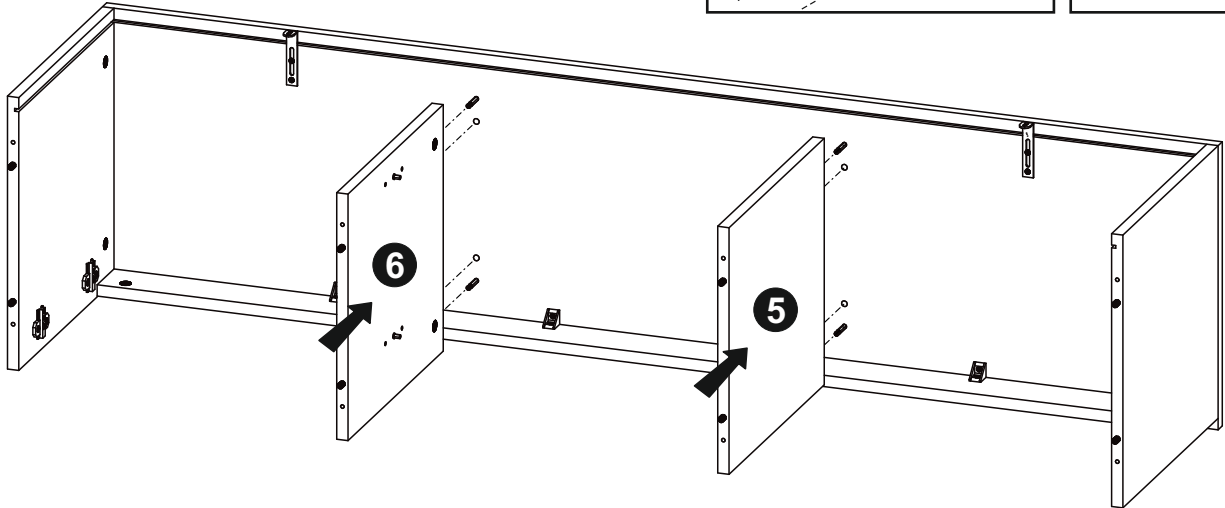
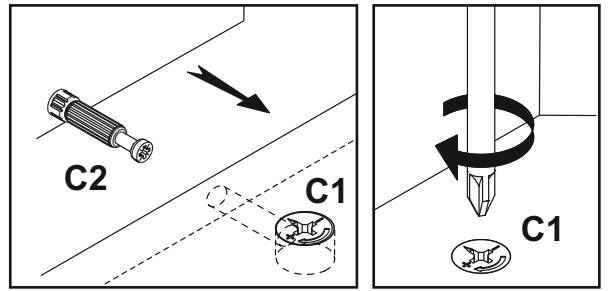



8

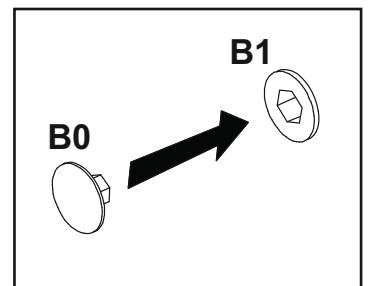
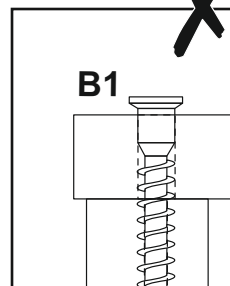
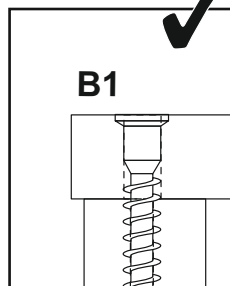
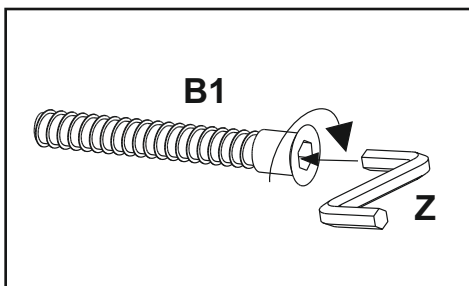
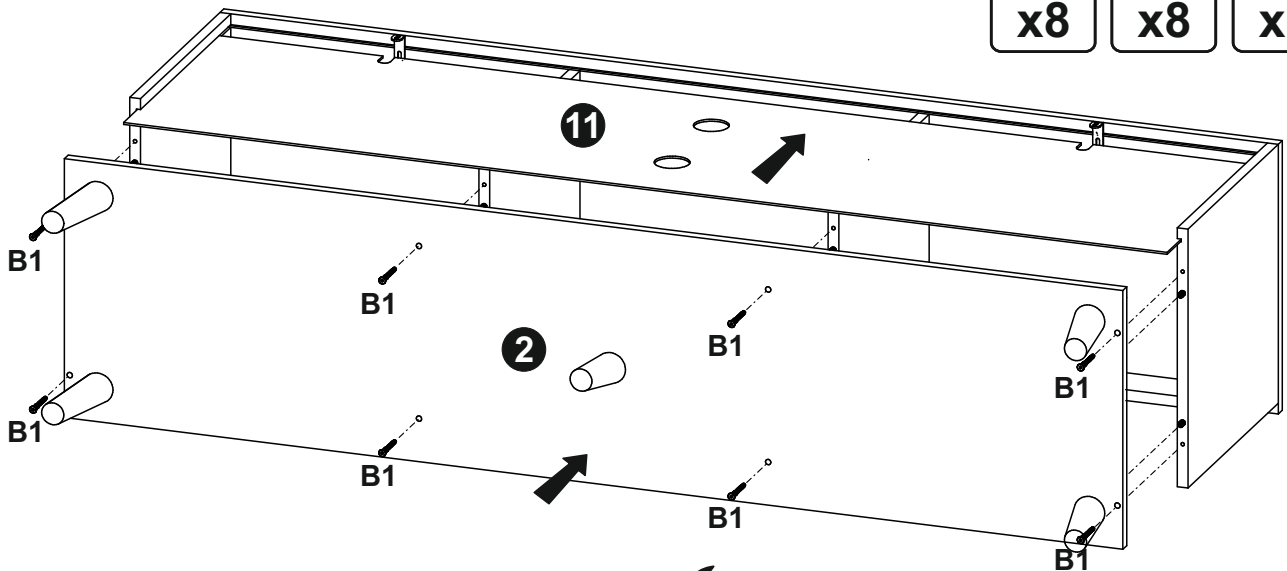



B0	B1	Z
x8	$\text{Ø}7 \times 50$ x8	4mm x1

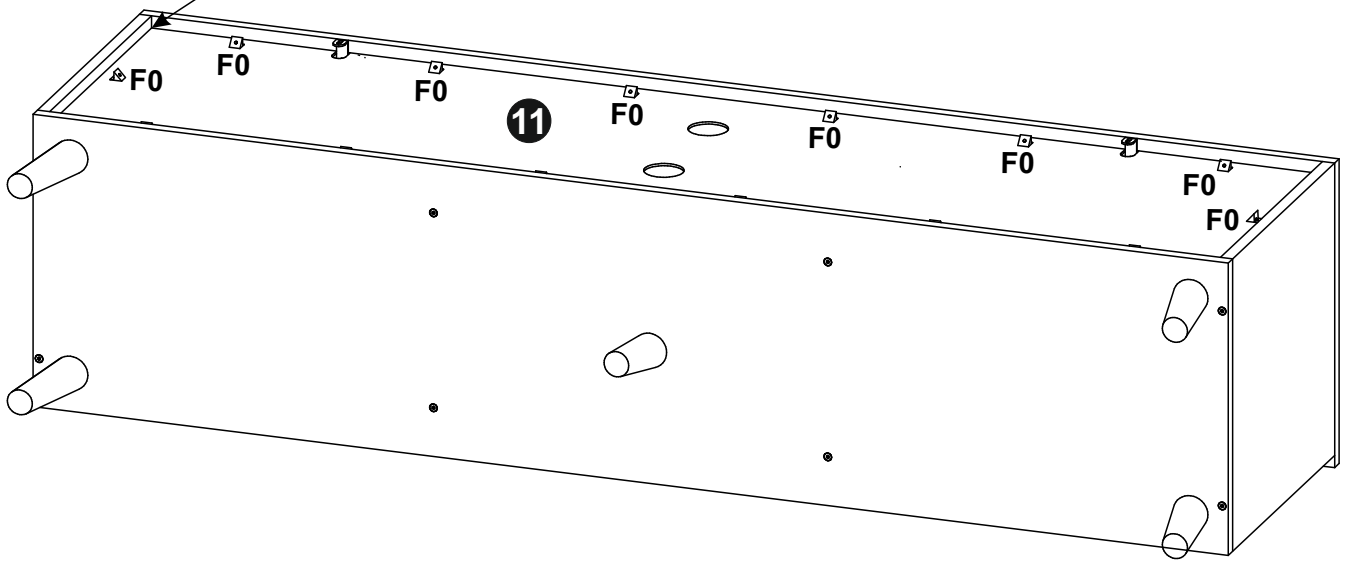
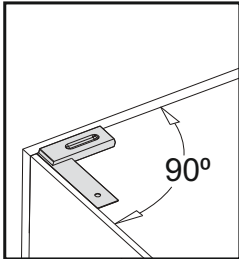

9

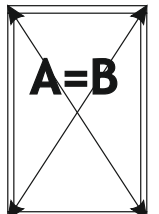
D0	F0
	
3x15	
x14	x14

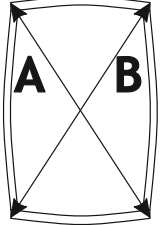

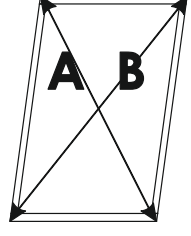
 	 	 
--	--	--

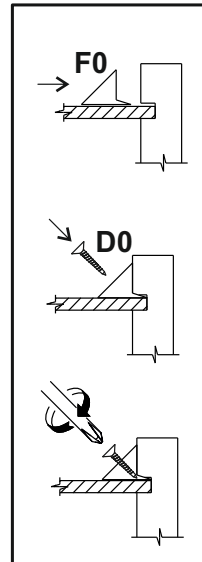

10

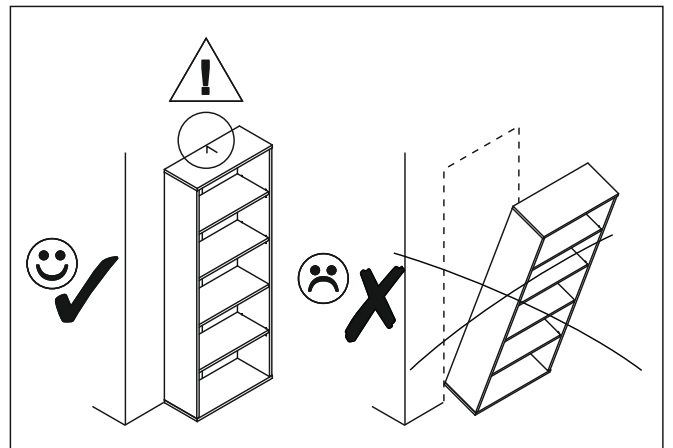
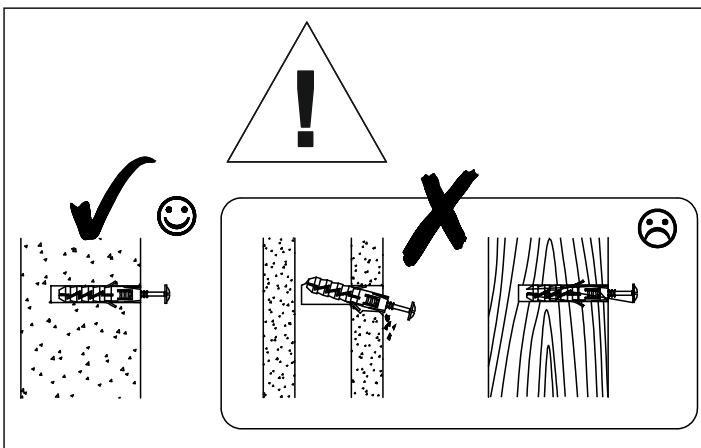
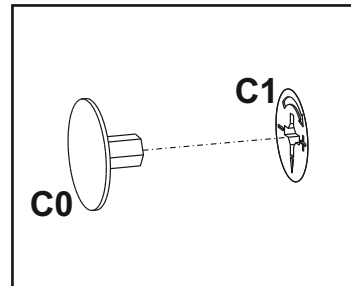
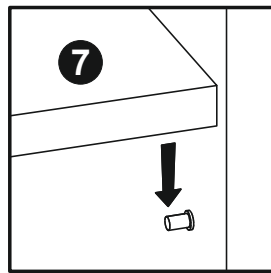
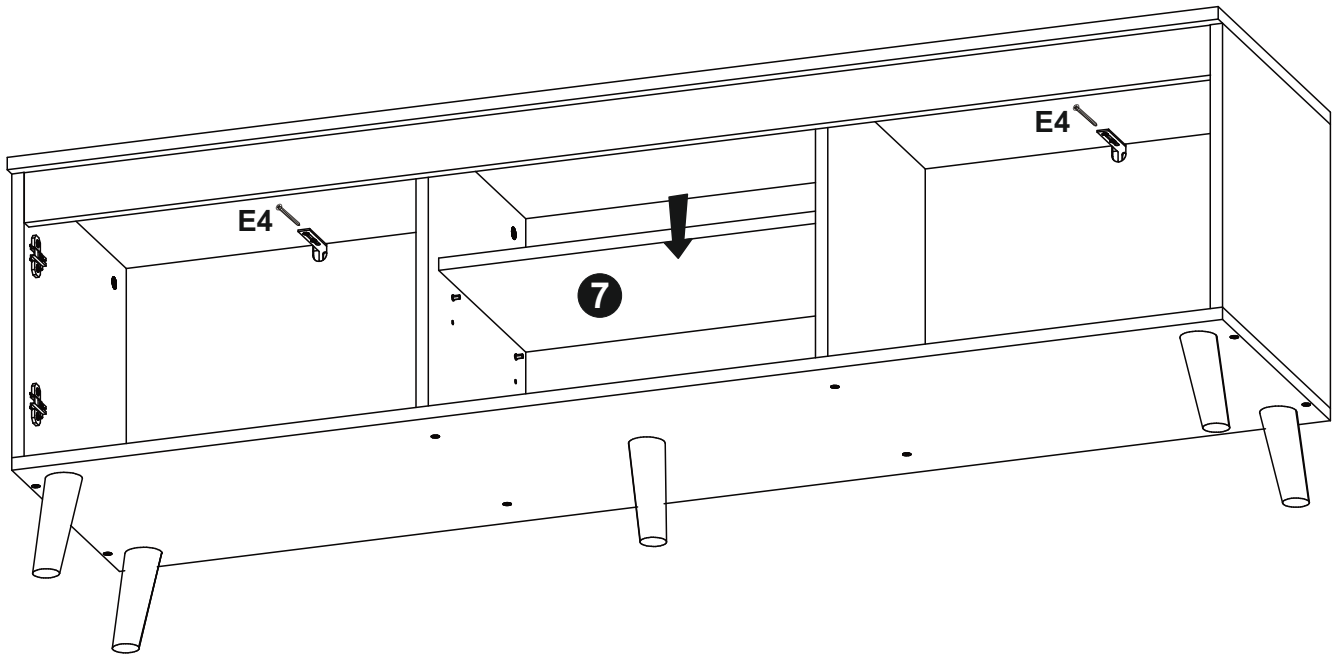
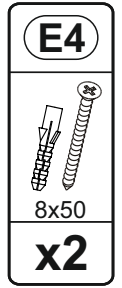
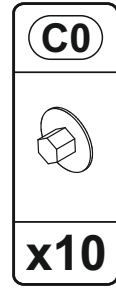
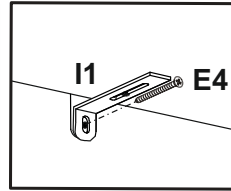
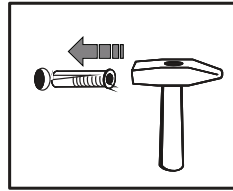
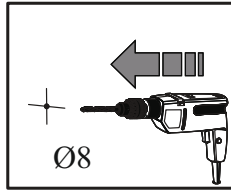
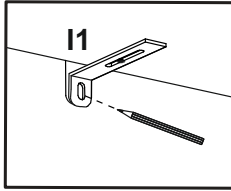

11

