

A		1
B		1
C		1
D		8

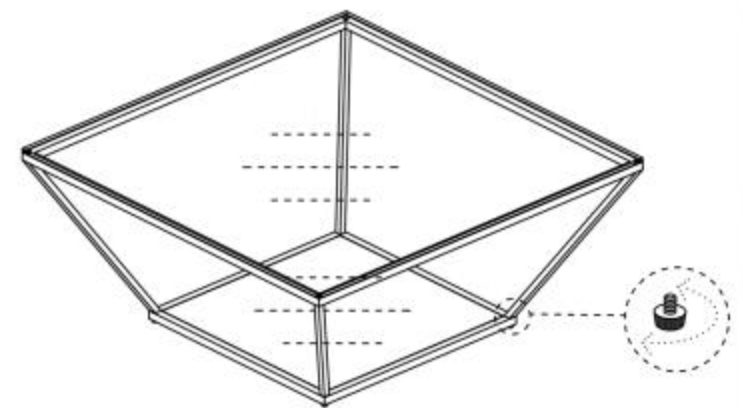
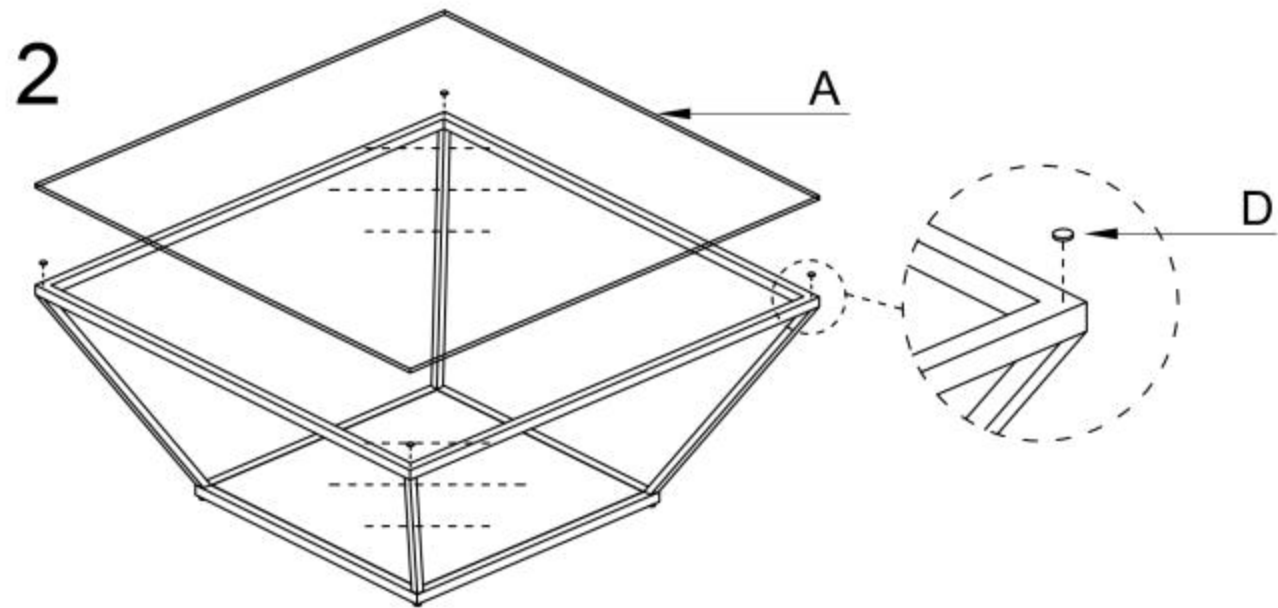

max. 15 kg