

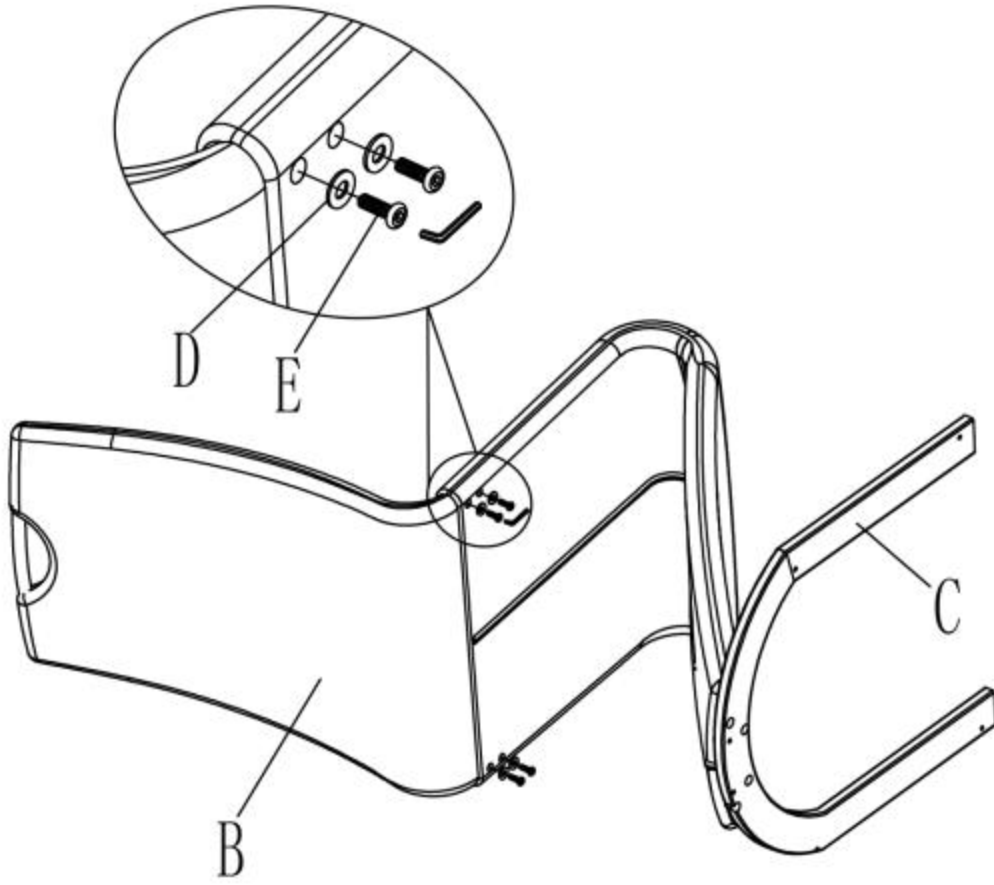

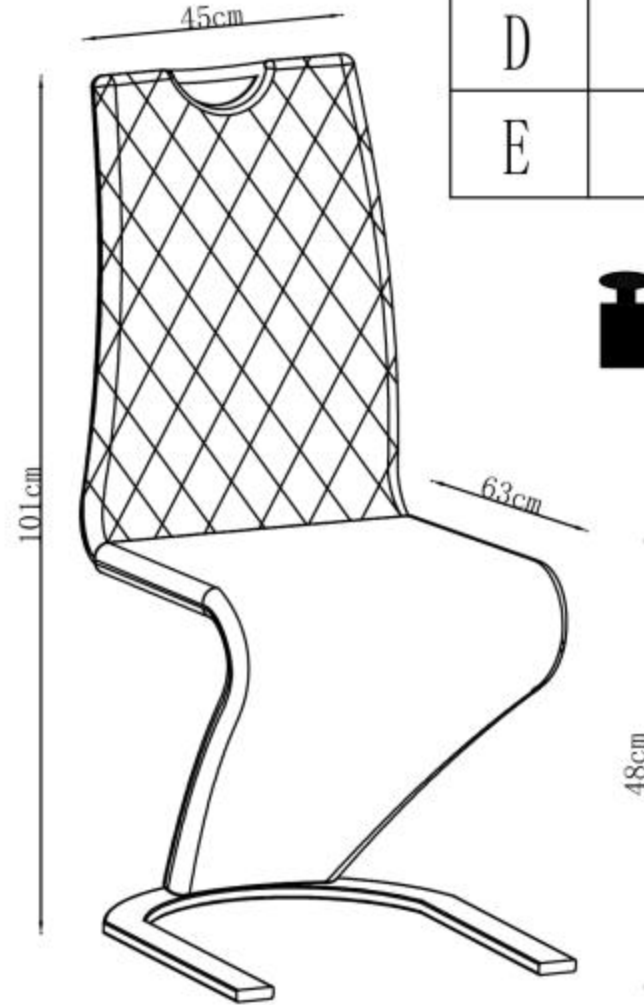



1



2



| | | |
|---|--|---|
| A |  | 1 |
| B |  | 1 |
| C |  | 1 |
| D |  | 4 |
| E |  M6 x 16 | 4 |

 max. 100kg