









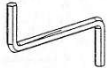

| | | | | | |
|---|---|---|---|---|---|
|  |  |  |  |  |  |
| K | KD | KL | W - Ø3,5x16 | W1 - Ø3,5x25 | G |
|  |  |  |  | | |
| ZS | U | ZK | PG | | |

1



2

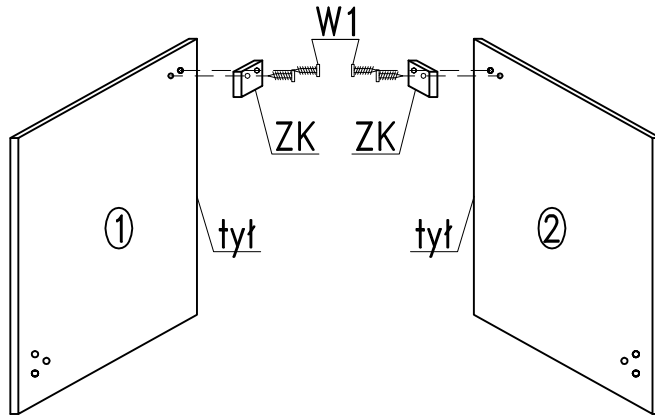
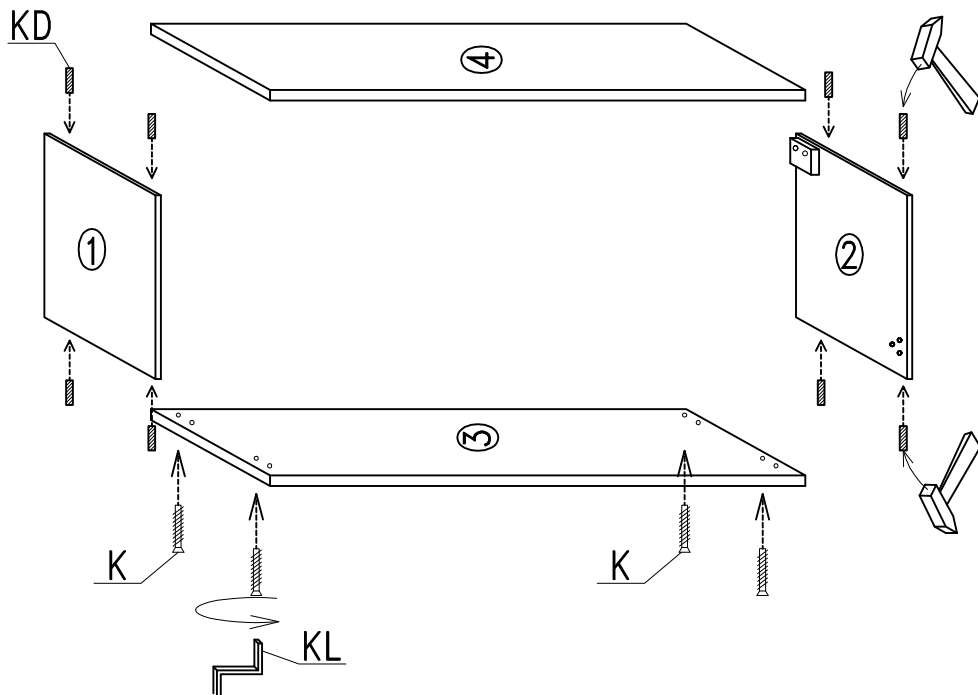

3

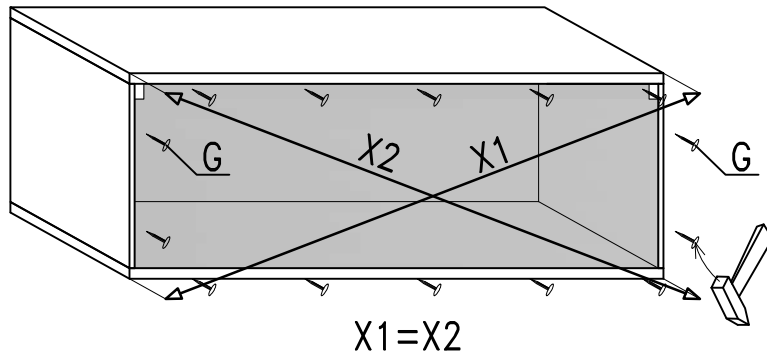

4

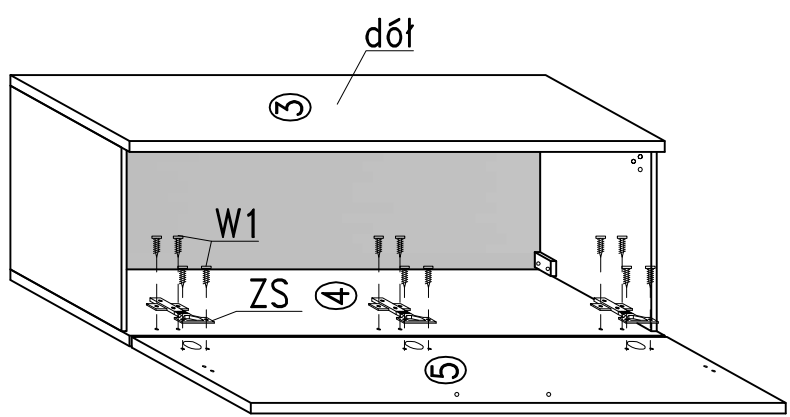

5

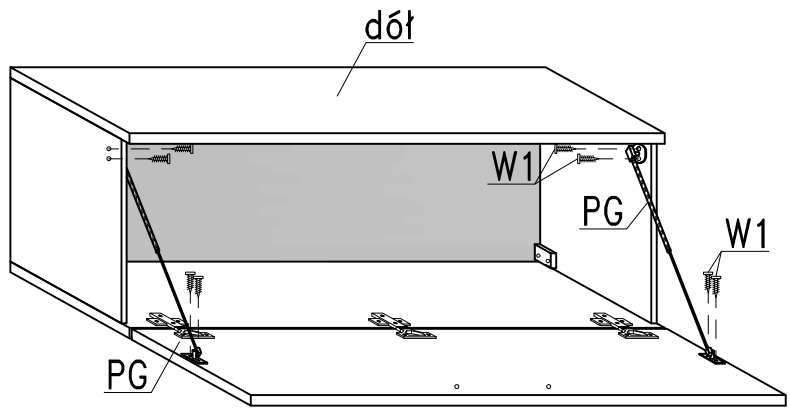

6

