

K	KD	KL	W - Ø3,5x16	G	B
ZS	U	N	P1	P2	

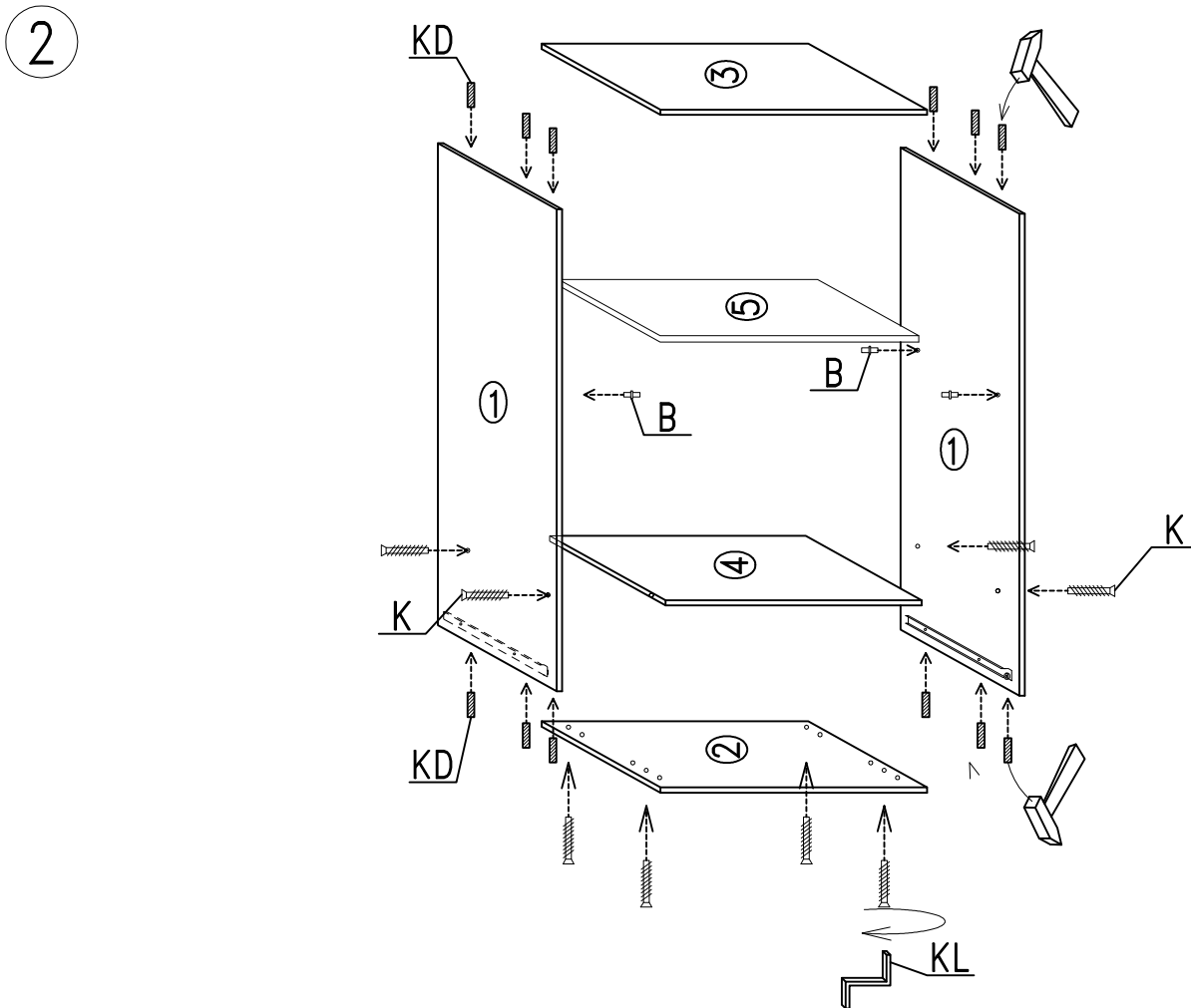

4

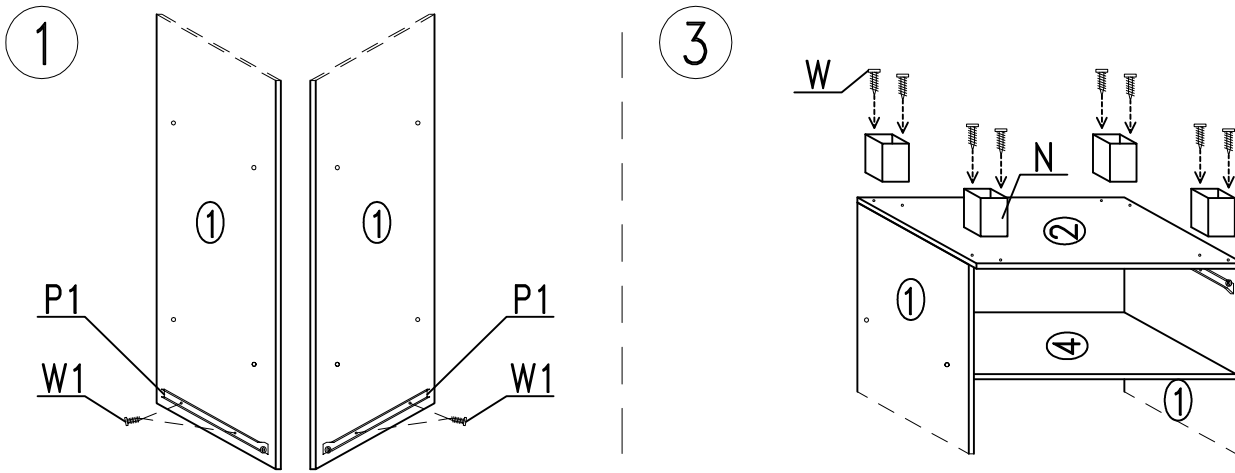
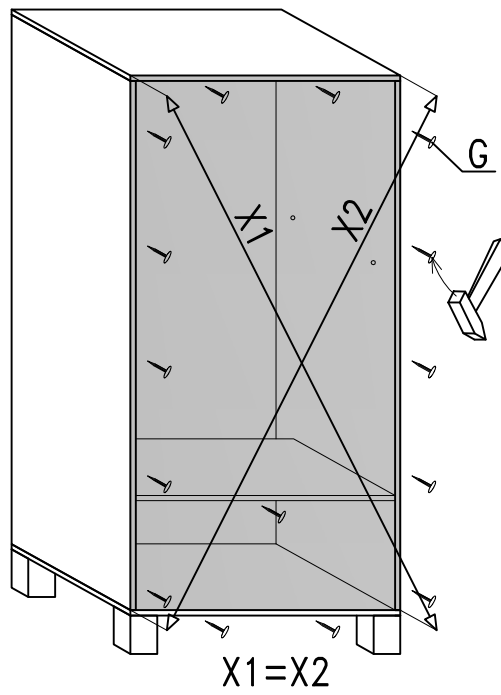

5

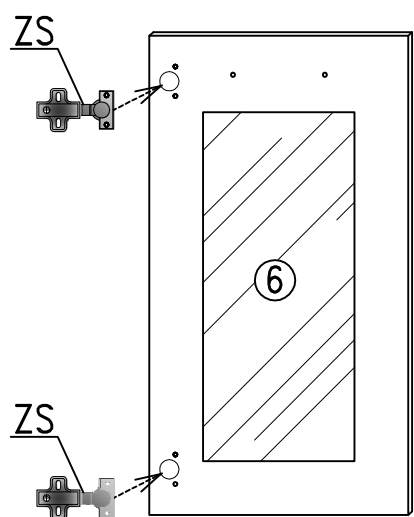

6

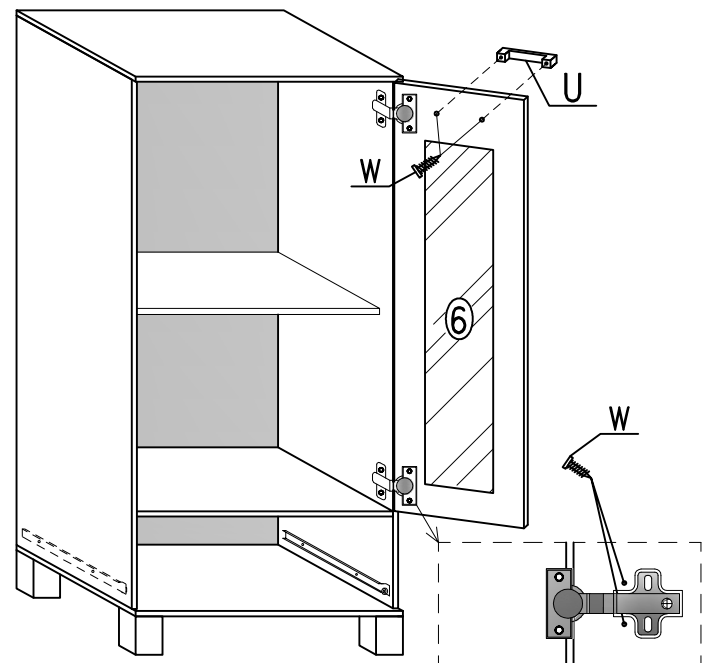

7

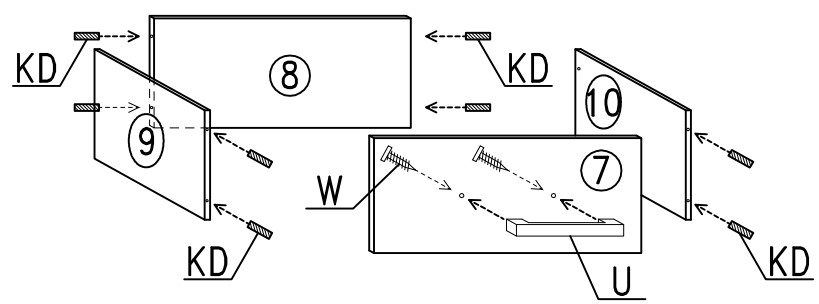

8

