











A	B	C	D	E	F	G	H	I	J	K
Stopki FI 50 H-40	Wkręt 3,5 cm	Nakrętka M8	Podkładka M8	Sruba maszynowa 8x45	Sruba maszynowa 8x60	Element tapicerowany	Element tapicerowany	Podłokietnik	Oparcie 131 cm	Oparcie 71 cm
										
10 szt.	15 szt.	2 szt.	8 szt.	4 szt.	2 szt.	1 szt.	1 szt.	2 szt.	1 szt.	1 szt.

KROK 1



KROK 2

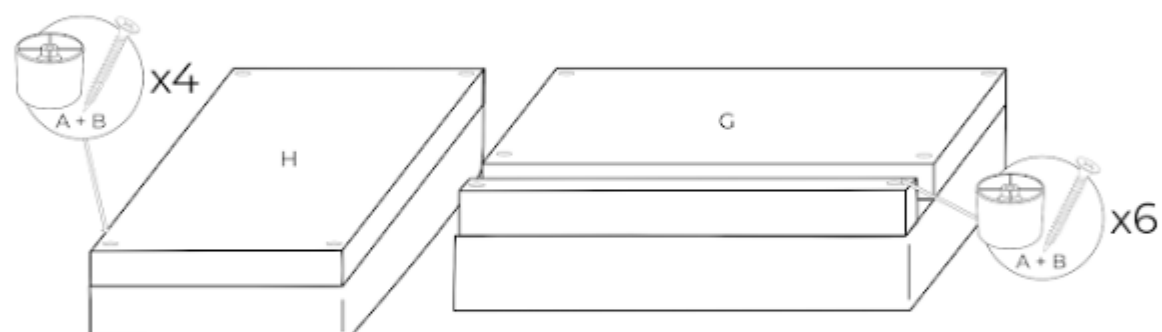