

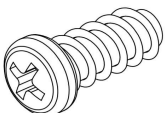

 A1	6,3 X 13  E13	 G	8 x 30  K	10 X 50  W60 K1
6,3 X 50  KN	 KR	15 x 12  M	h:160mm  NV	 PE
 SB	 ST	6 x 34 mm  T	4 x 16  W16	 Z
 ZPH				

BL [1]	350	334	1	A1	1
BP [2]	350	334	1	E13	16
FT1 [3]	598	355	1	G	10
FT2 [4]	598	355	1	K	12
FT3 [5]	598	355	1	K1	2
PC [6]	1777	336	1	KN	4
PPI01 [7]	331	318	1	KR	2
PPI02 [8]	331	318	1	M	12
WD [9]	1767	331	1	NV=160mm	4
WG [10]	1800	350	1	PE	6
				SB	3
				ST	6
				T	12
				W16	31
				W60	2
				Z	12
				ZPH	6

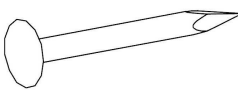
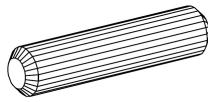
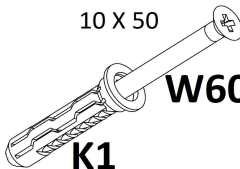

1.

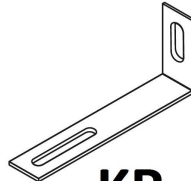

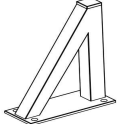
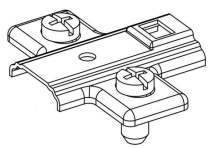
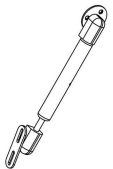
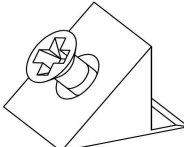
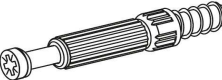
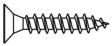
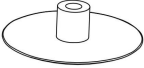
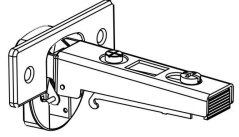
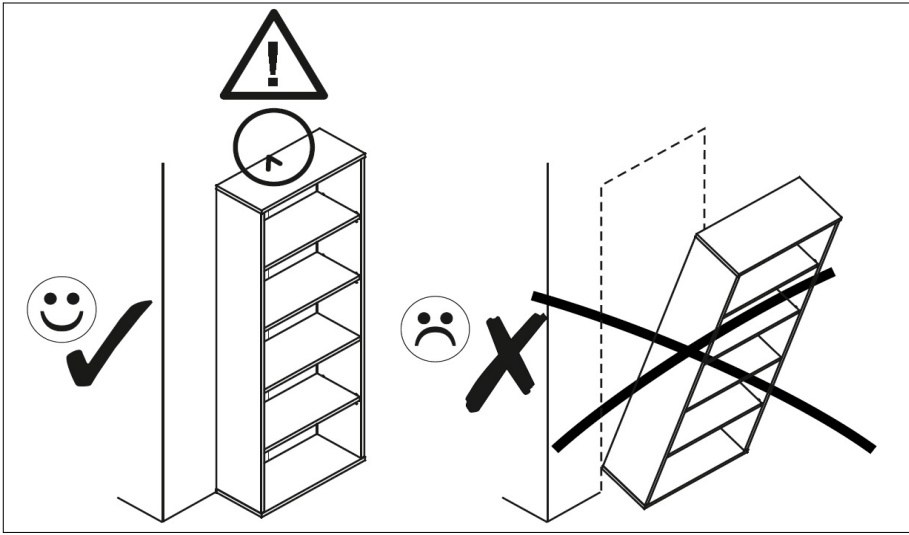
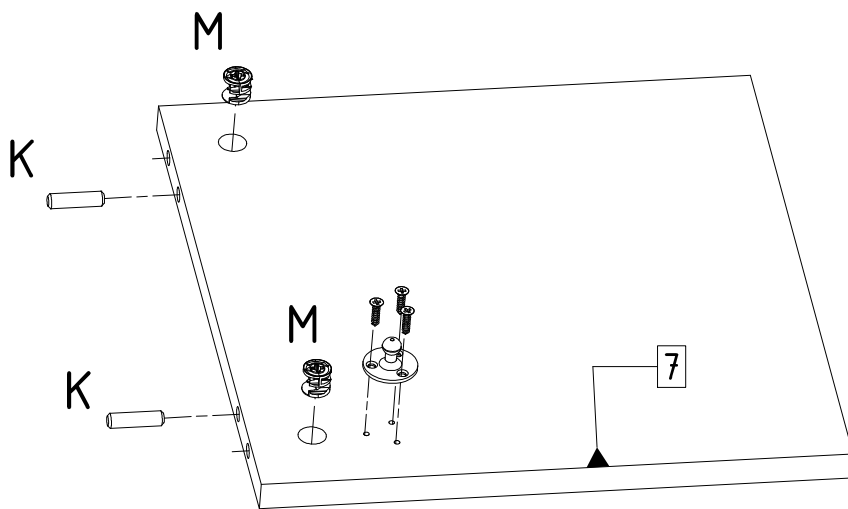
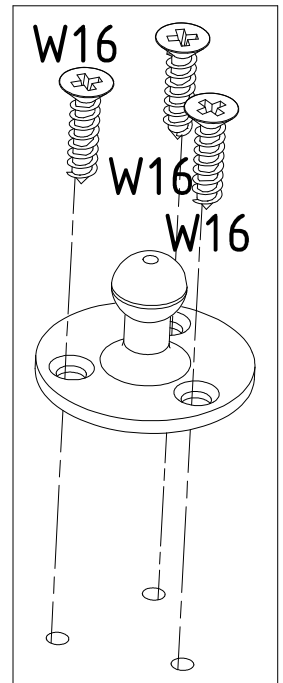
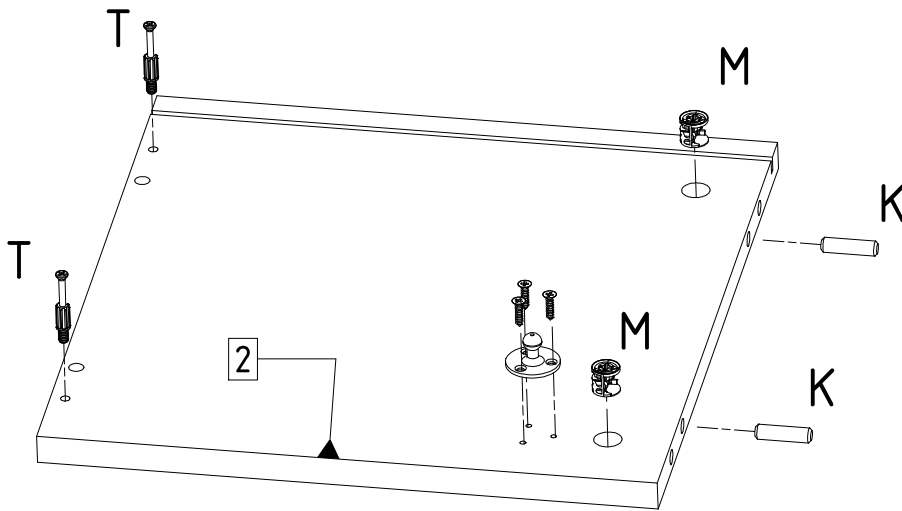
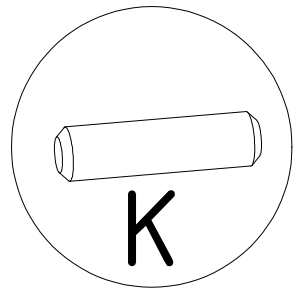
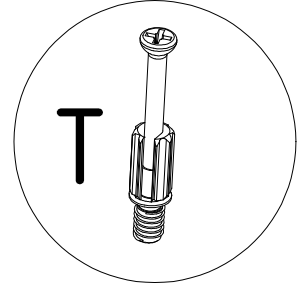
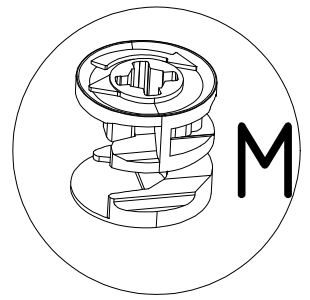
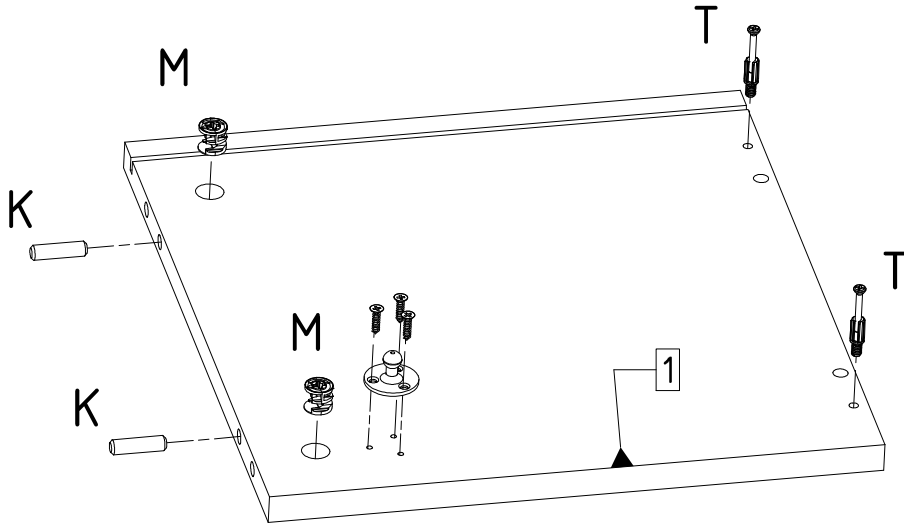
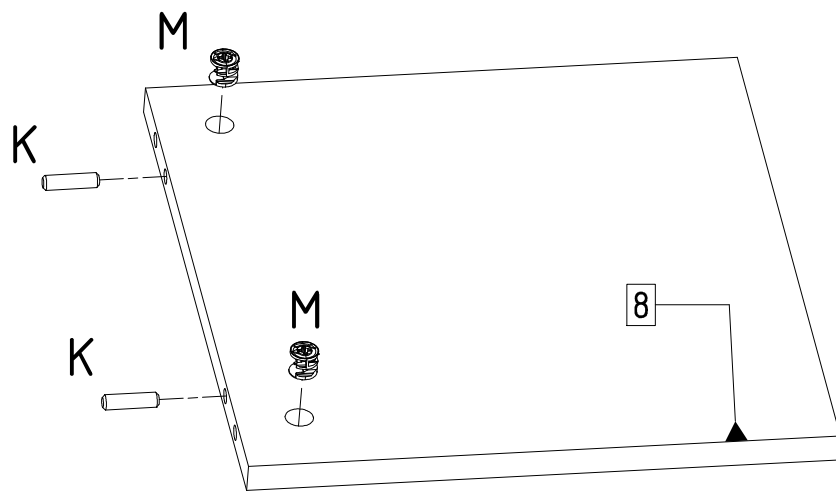

2.

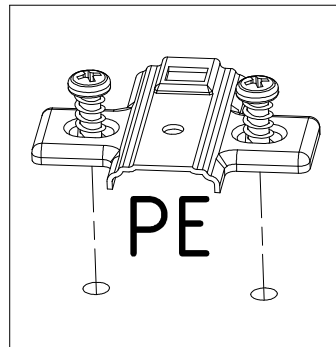

1.

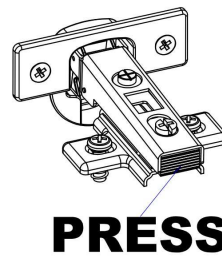

2.

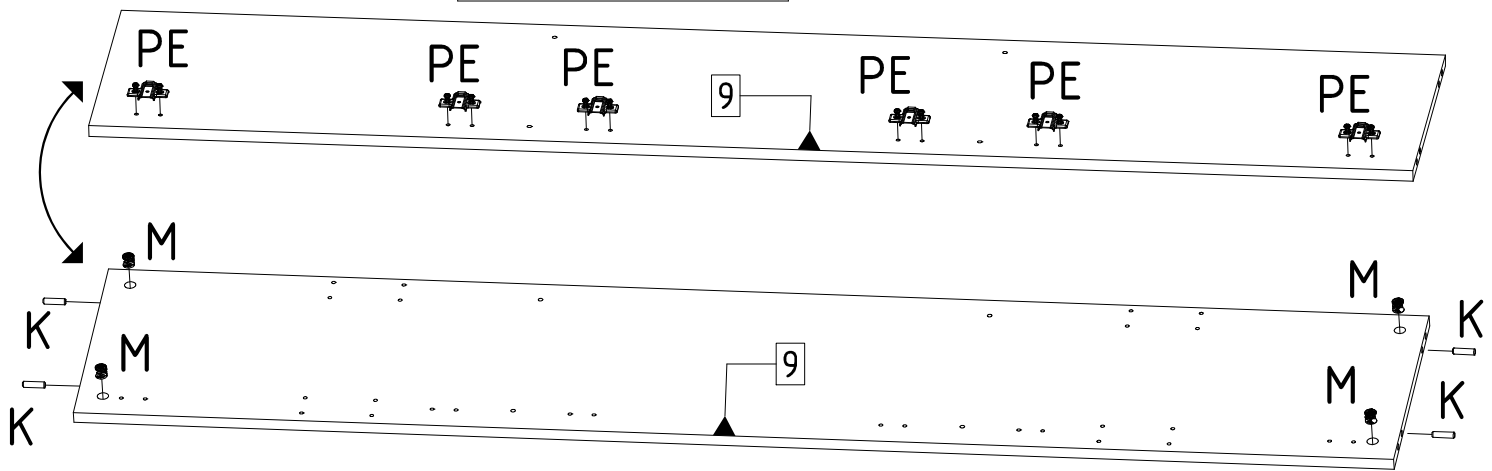
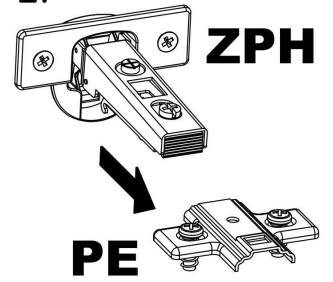

3.

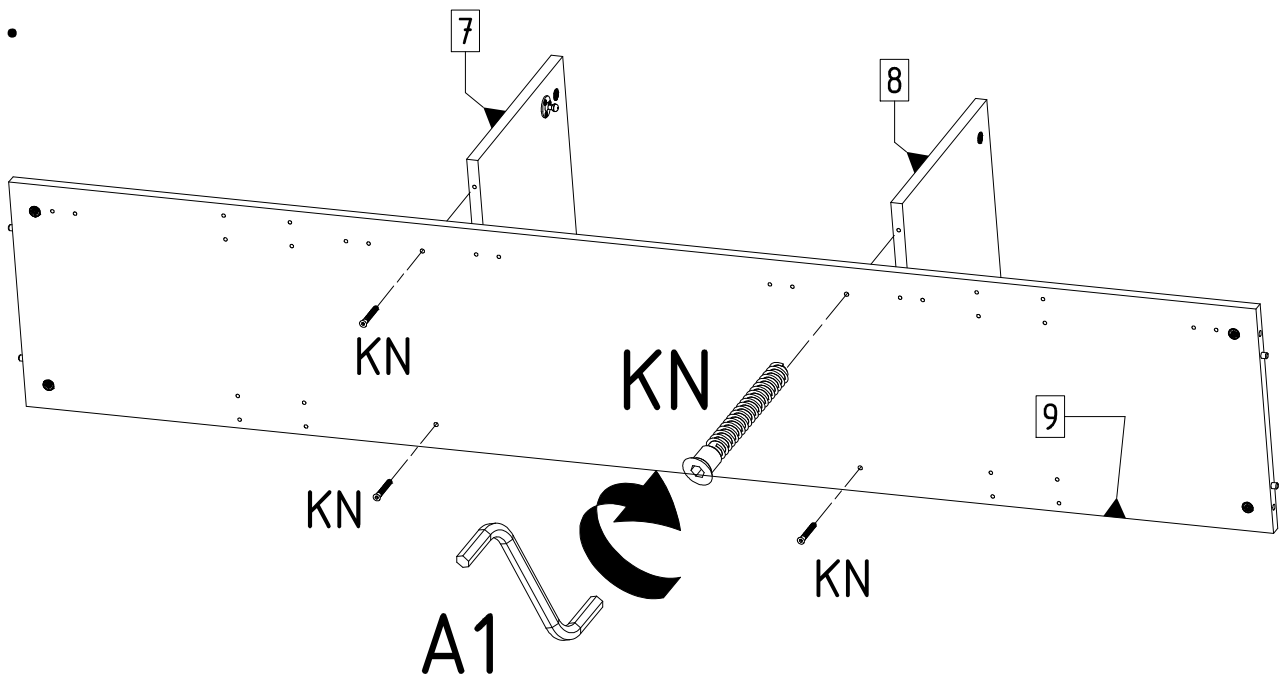

4.

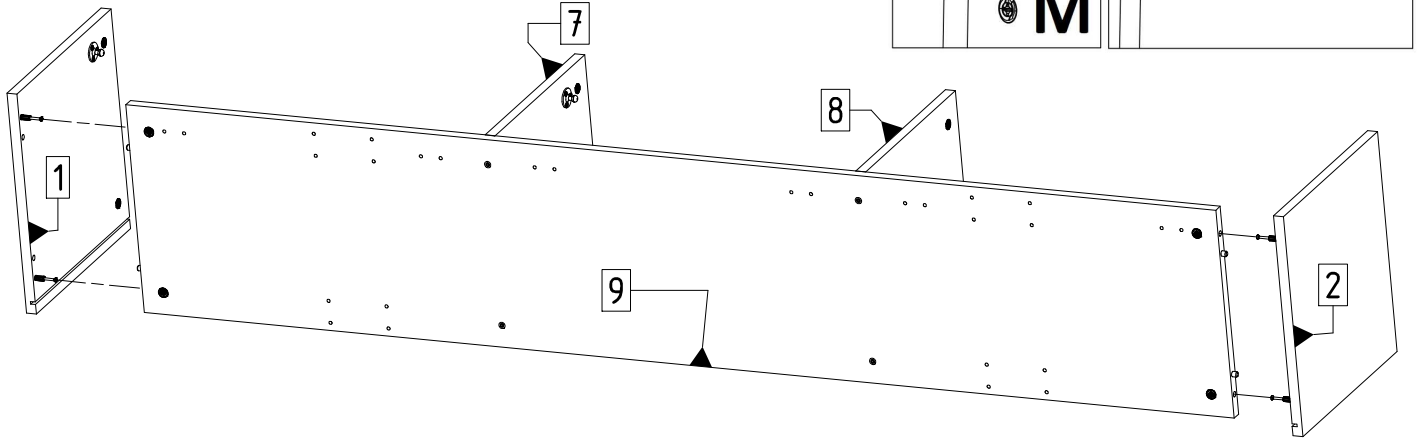

5.

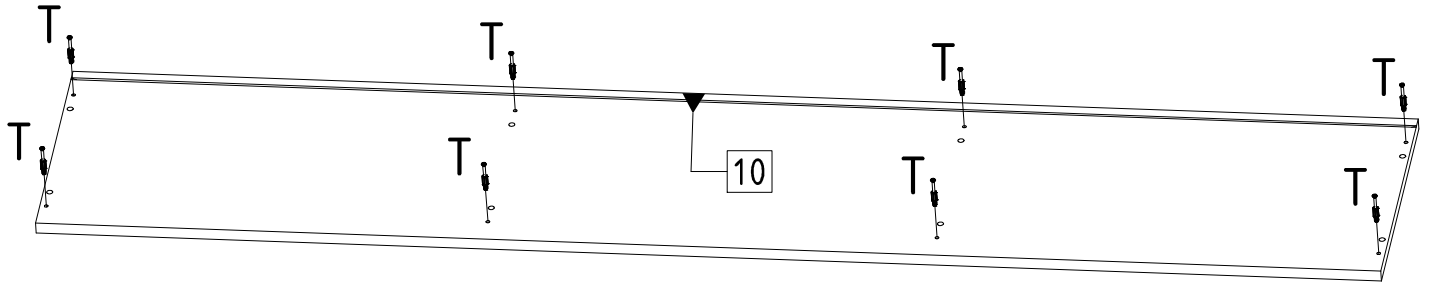

6.

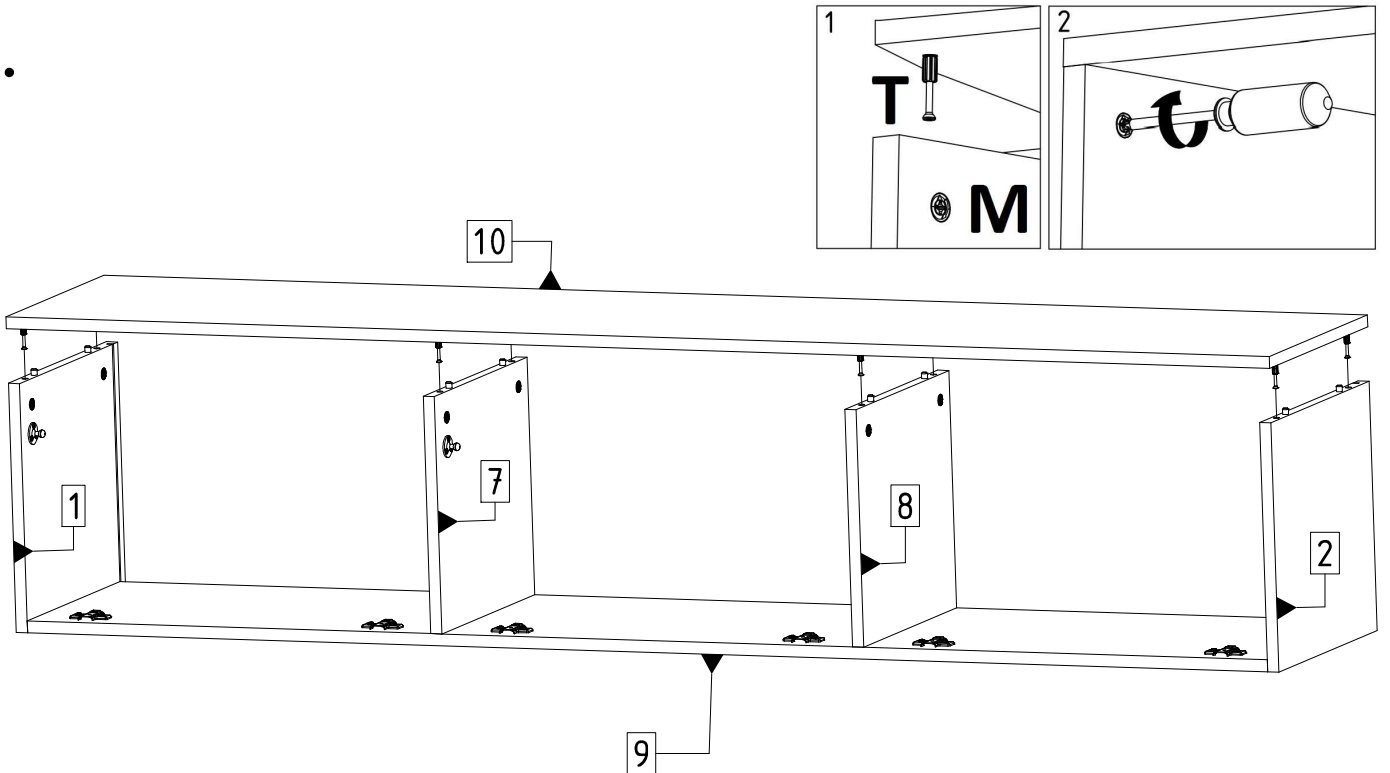

7.

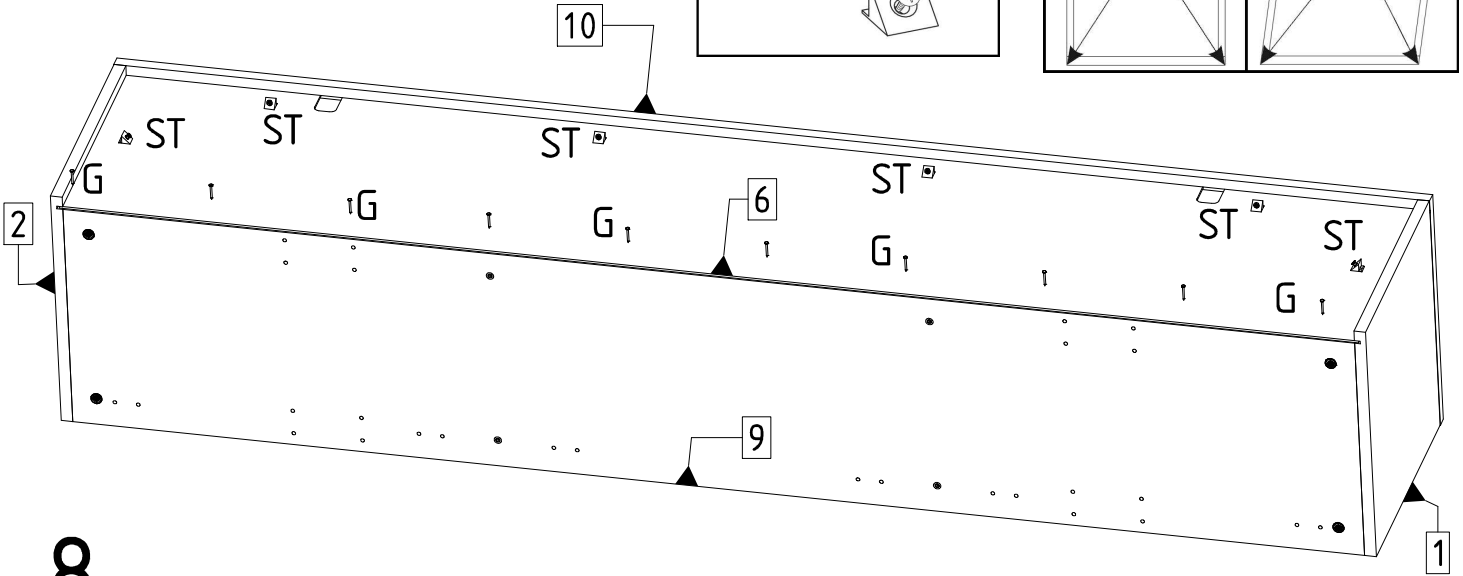
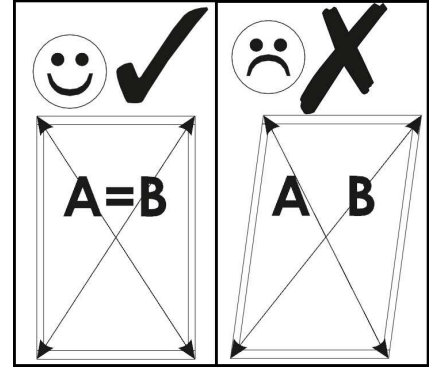
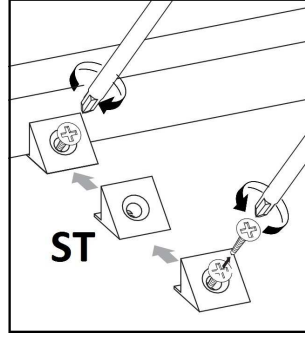
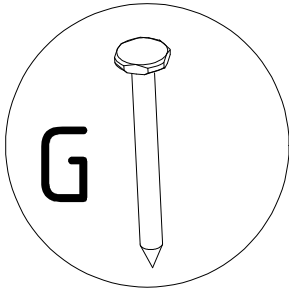

8.

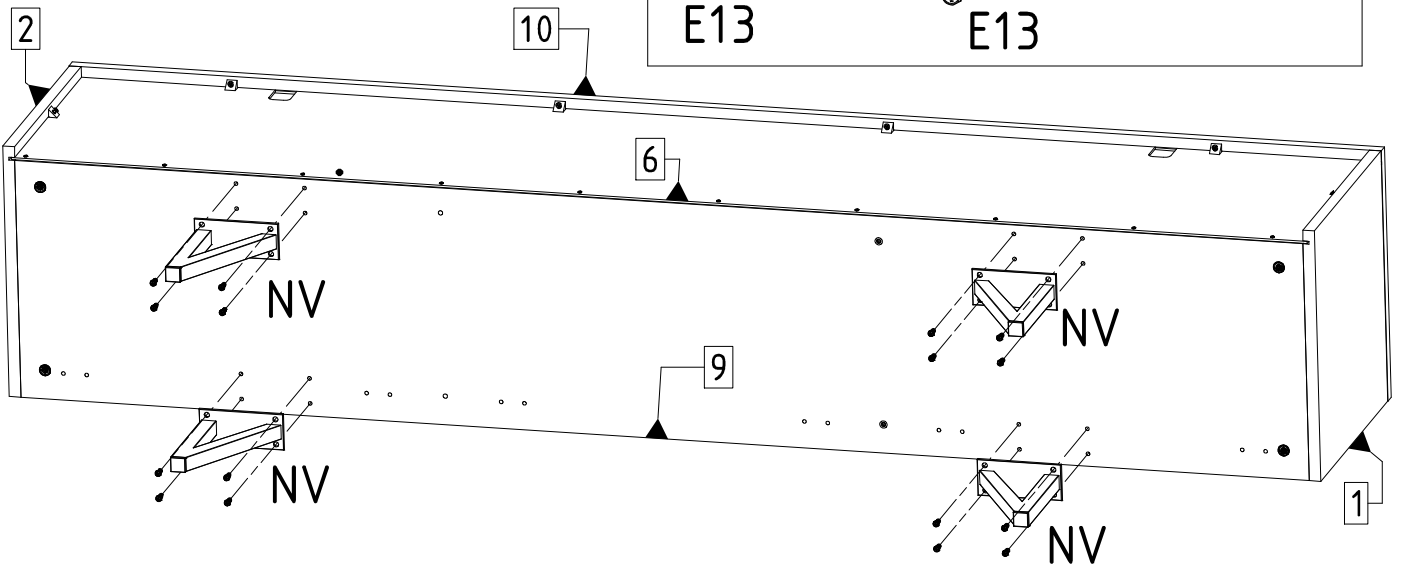
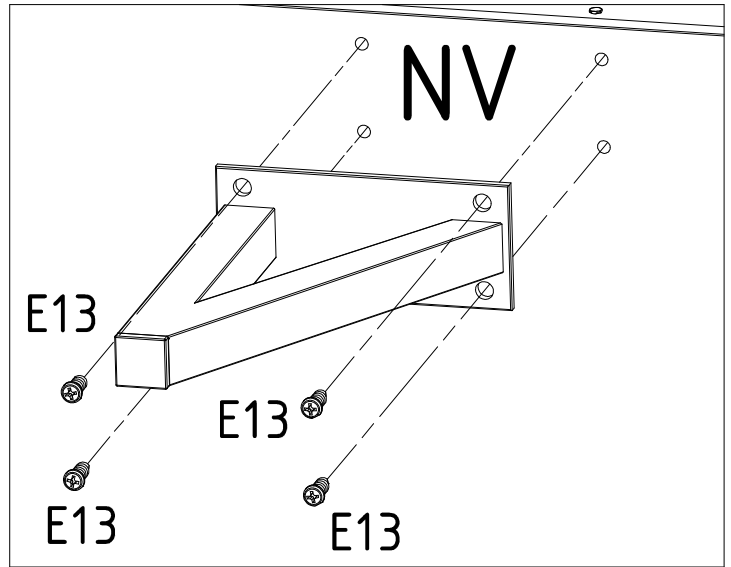

9.

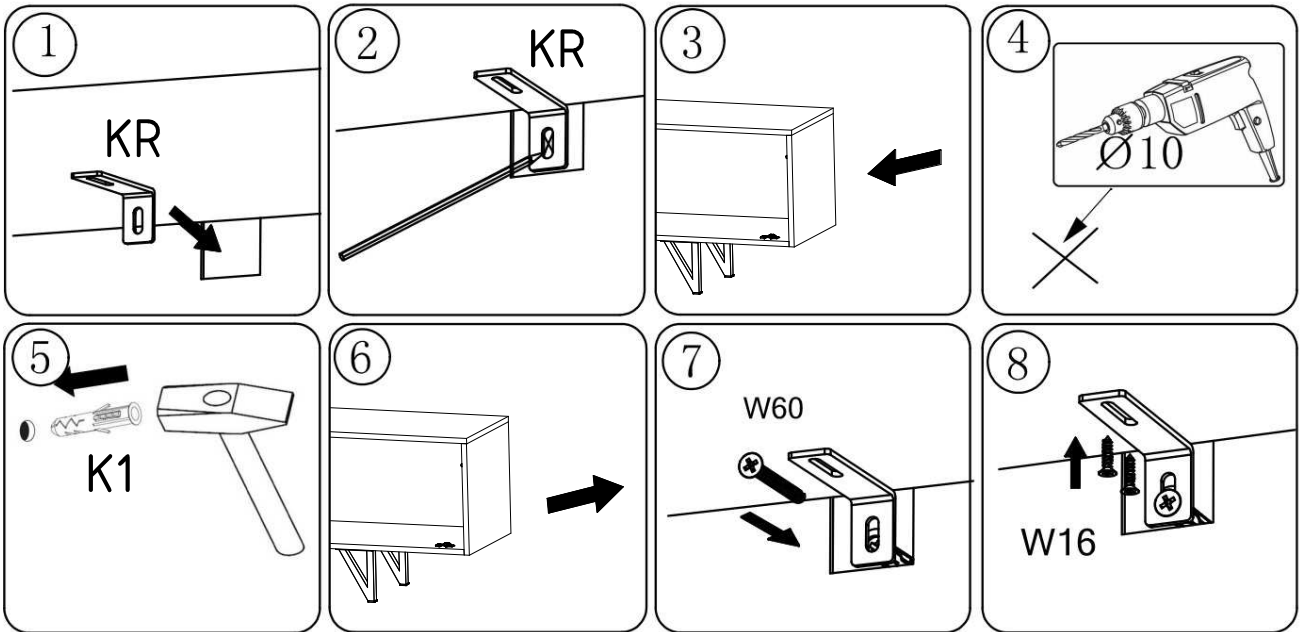
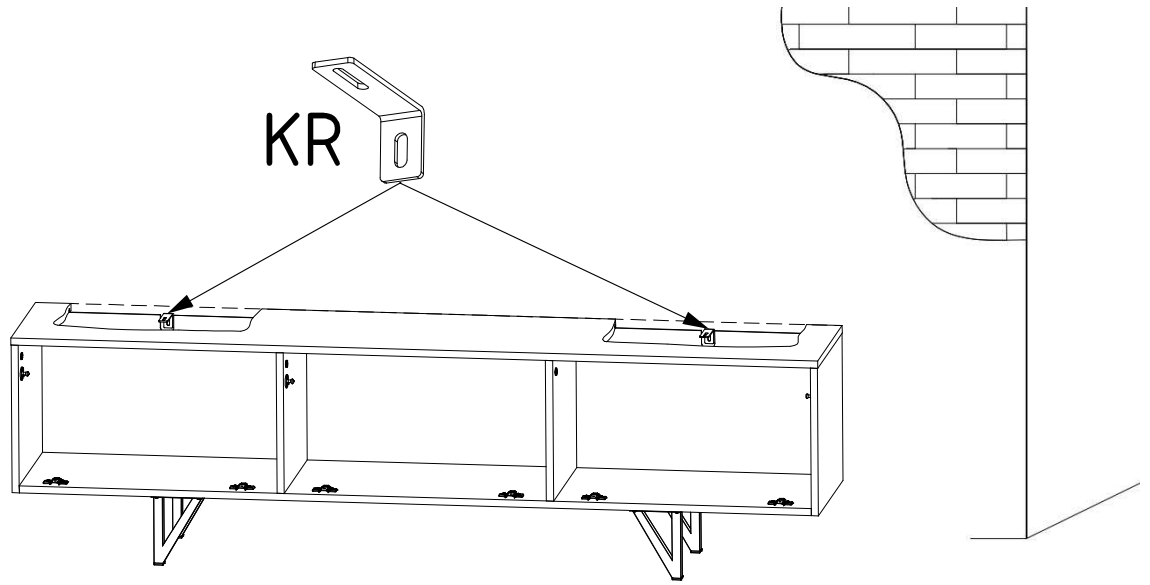

10.

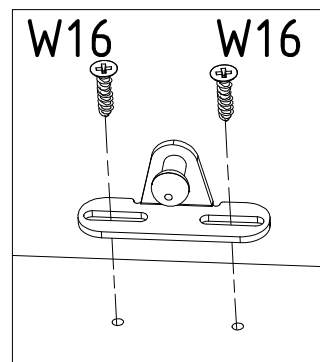
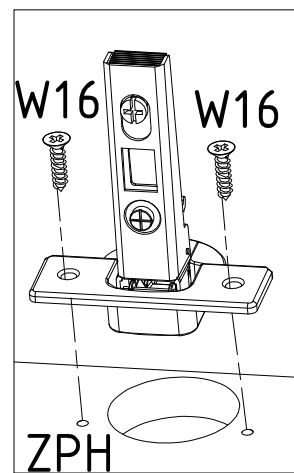
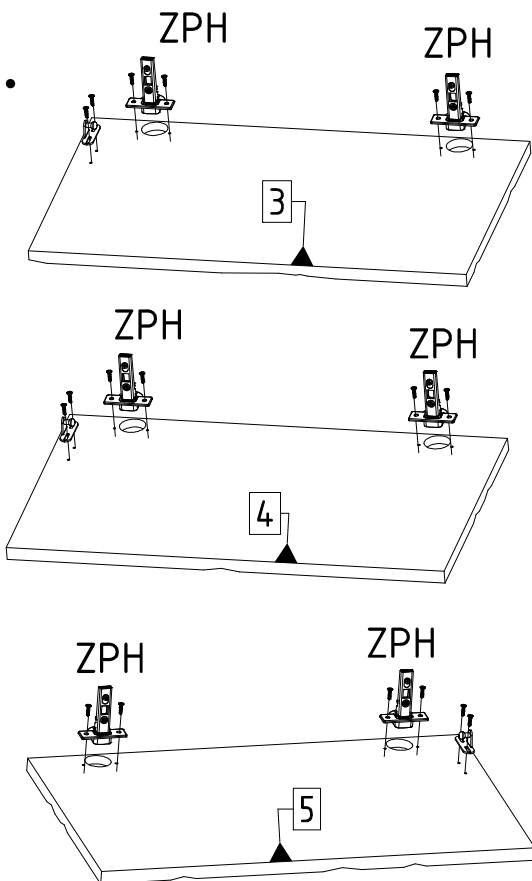

11.

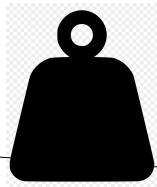
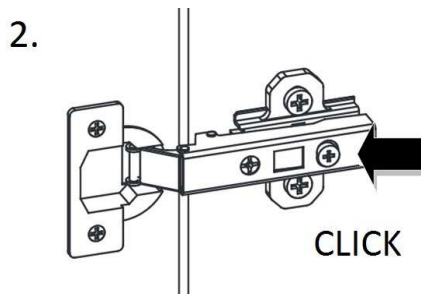
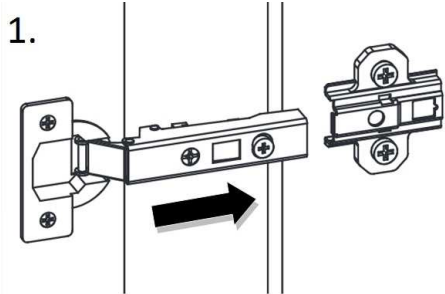

max.
20 kg

