

x 4

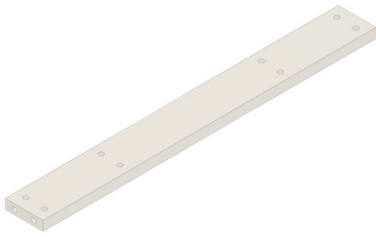

x 2



x 5

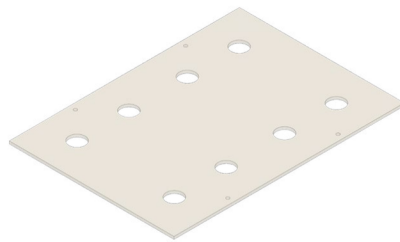

x 2

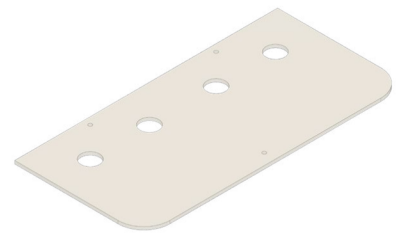

x 2

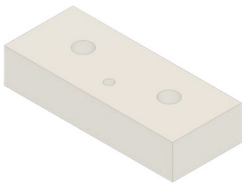

x 2



x 16



M6x60  
x 24



x 12



M6x35  
x 14











x 4



x 1



- |   |   |   |   |
|---|---|---|---|
|  |  |  |  |
| x2  | x1  | x1  | x1  |
| 5   | 6   | 7   | 8   |
|  |  |  |  |
| x4  | M6x60<br>x6   | x2  | M6x35<br>x3   |

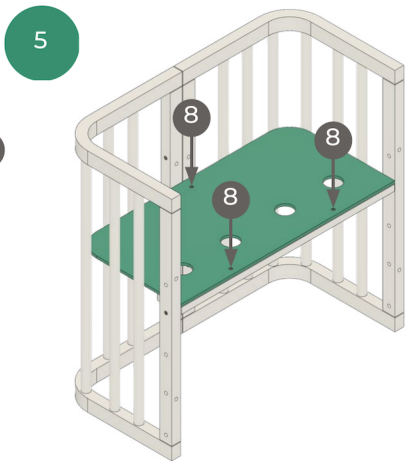
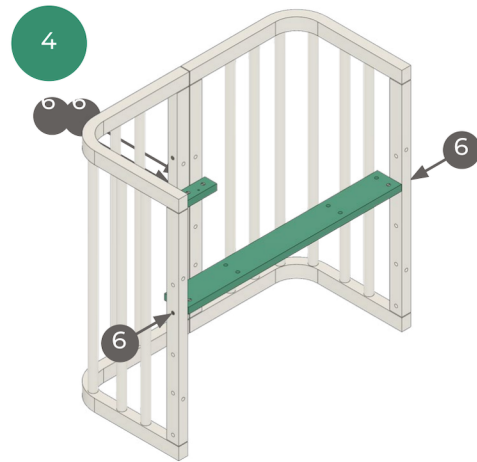
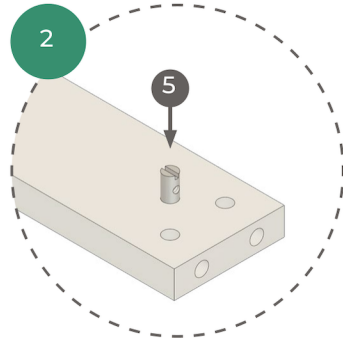
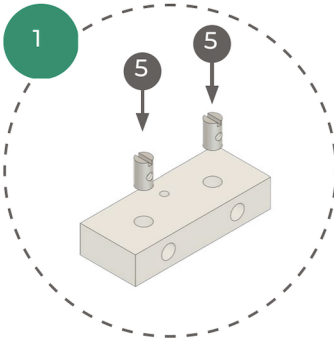

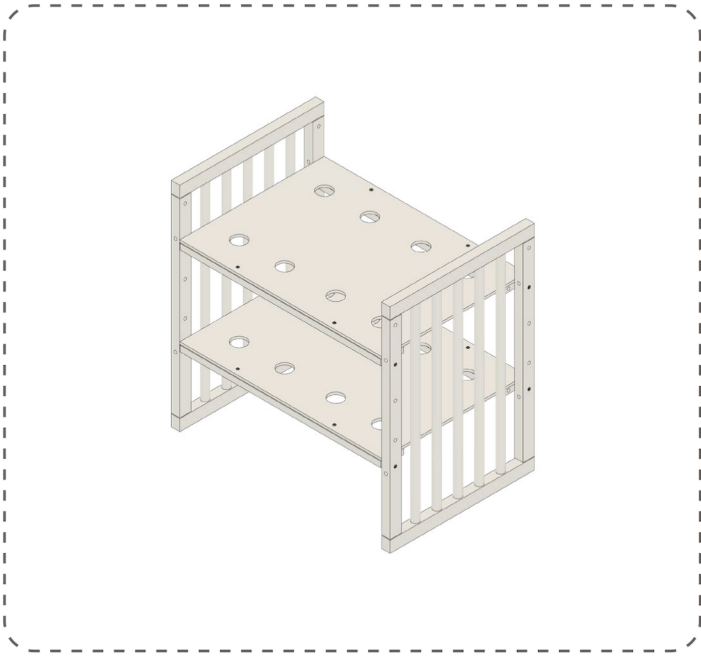

x2

x2

x4

4

5

6



x8

M6x60  
x 8

M6x35  
x 8

1

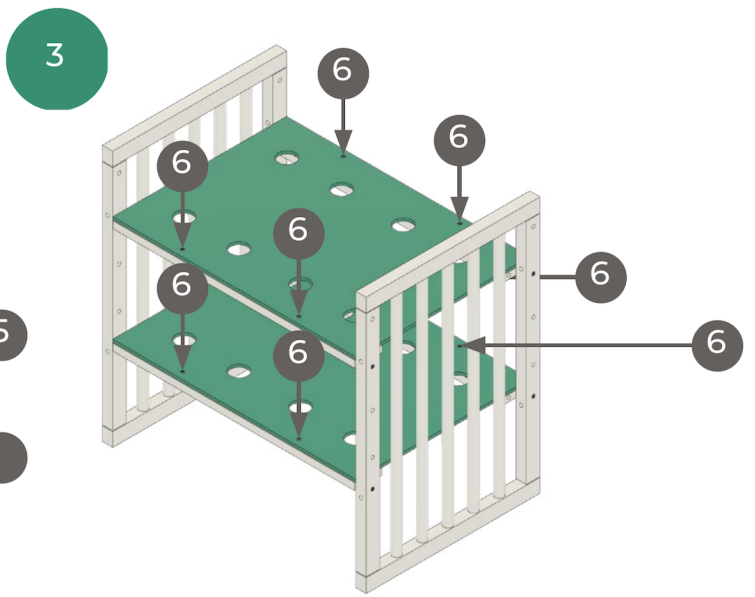
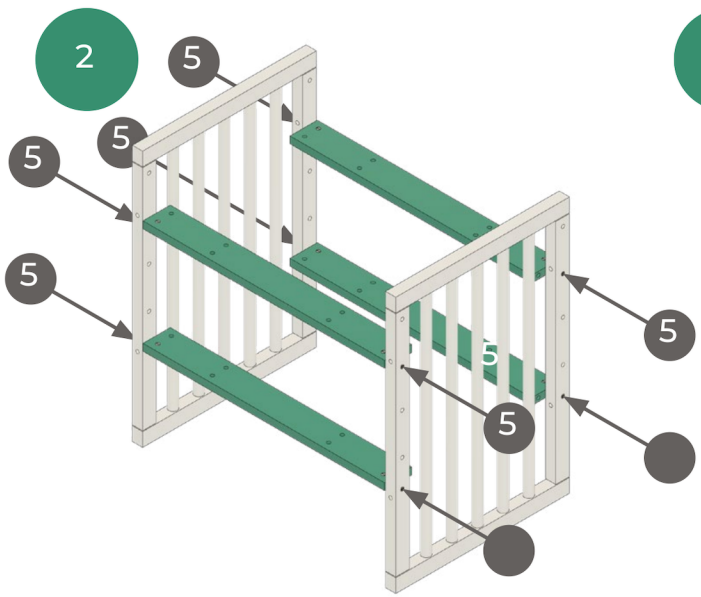
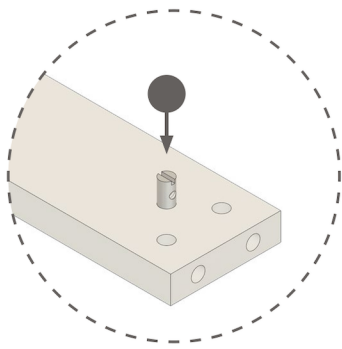



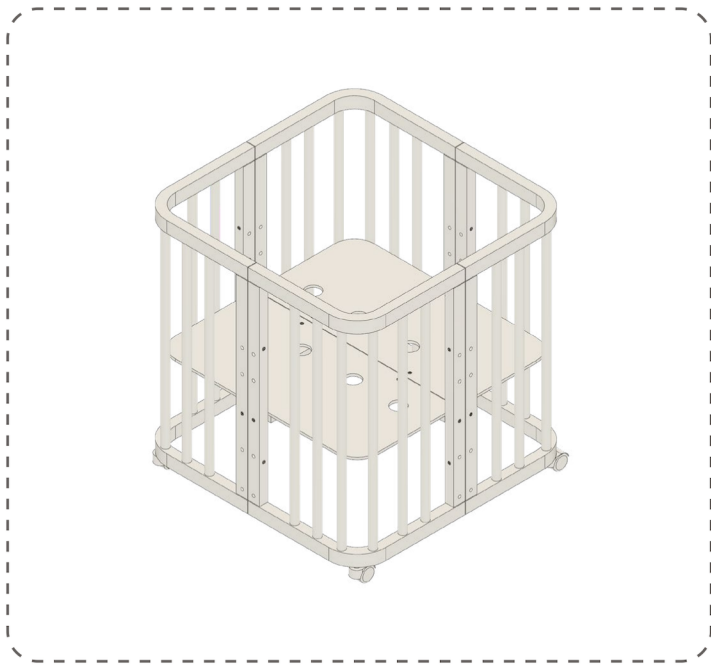

x4

x2

x1

x2

5

6

7

8

9



x8

M6x60  
x16

x8

M6x35  
x6

x4

