

E-1	2029	395	16	x1	1/2
E-2	2029	395	16	x1	1/2
E-3	352	394	16	x1	1/2
E-4	352	394	16	x1	1/2
E-5	352	345	16	x1	1/2
E-6	352	345	16	x1	1/2
E-7	352	345	16	x1	1/2
E-8	482	335	16	x1	1/2
E-9	346	496	16	x2	1/2
E-10	346	496	16	x1	1/2
E-11	2010	366	3	x1	1/2

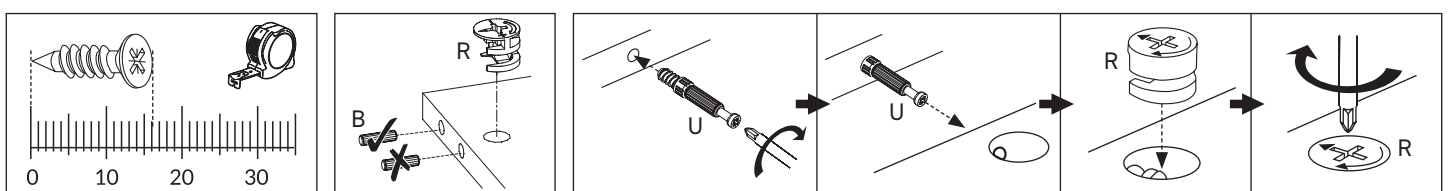

1

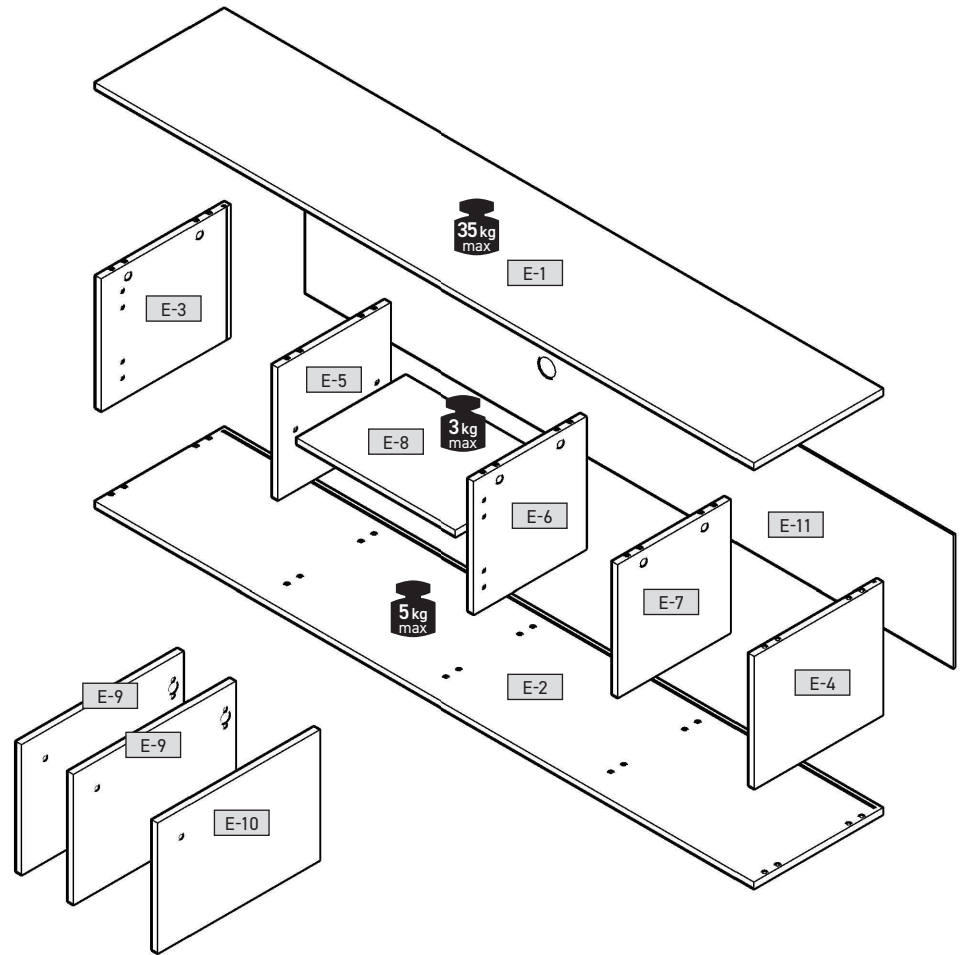
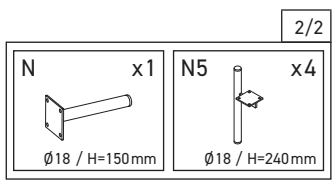
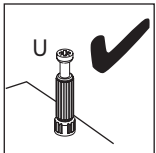
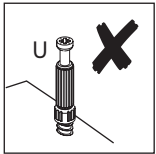
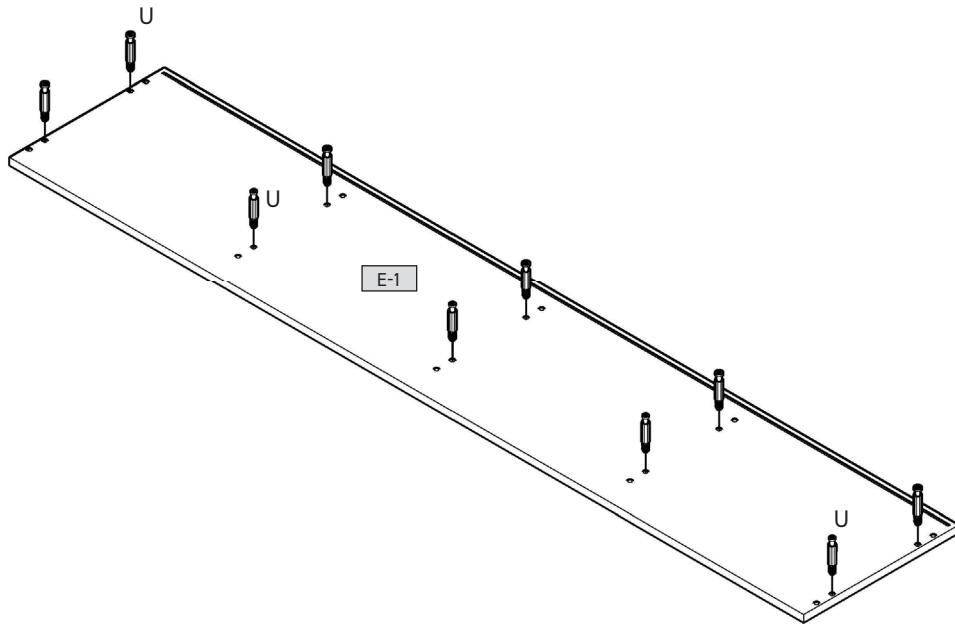
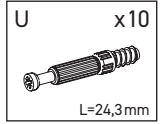

2

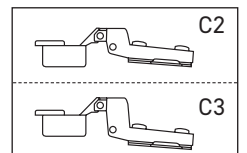
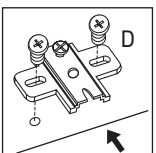
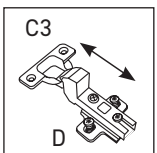
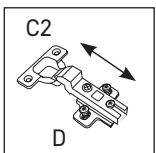
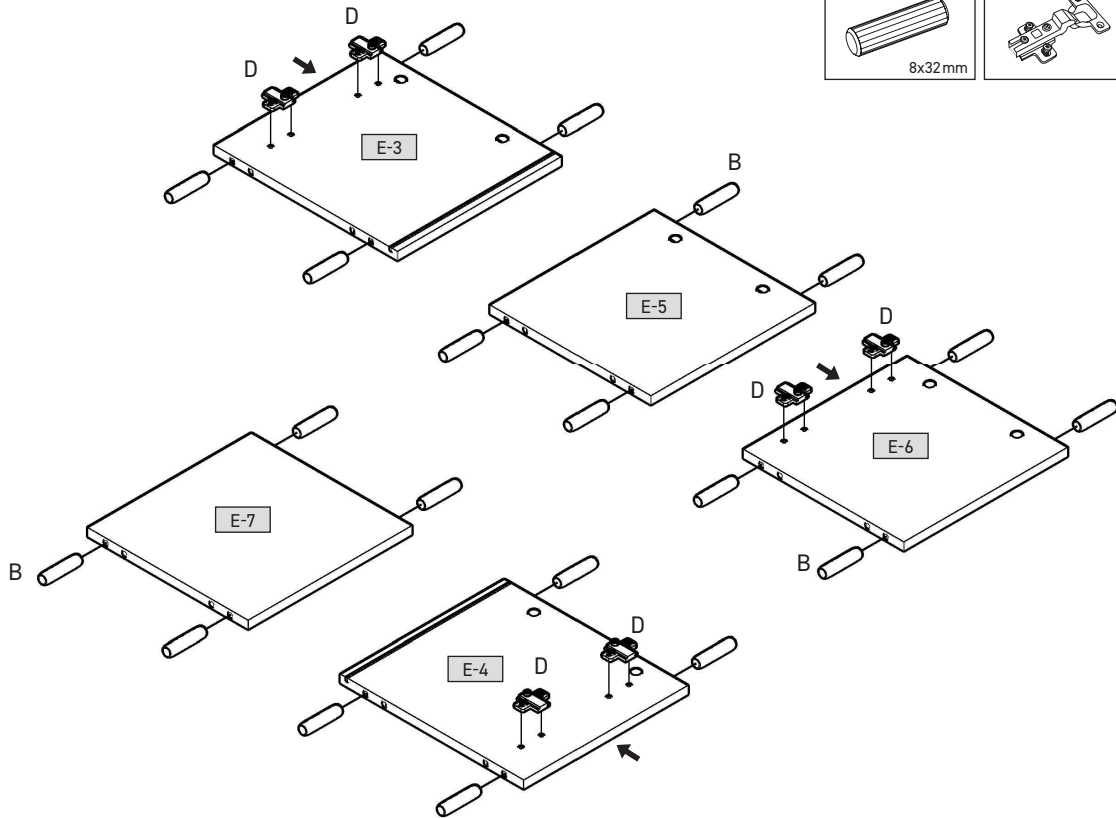
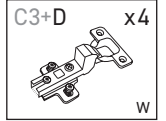
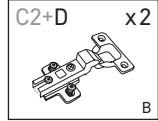
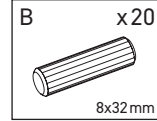

3

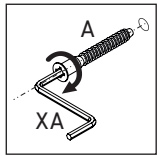
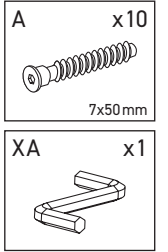
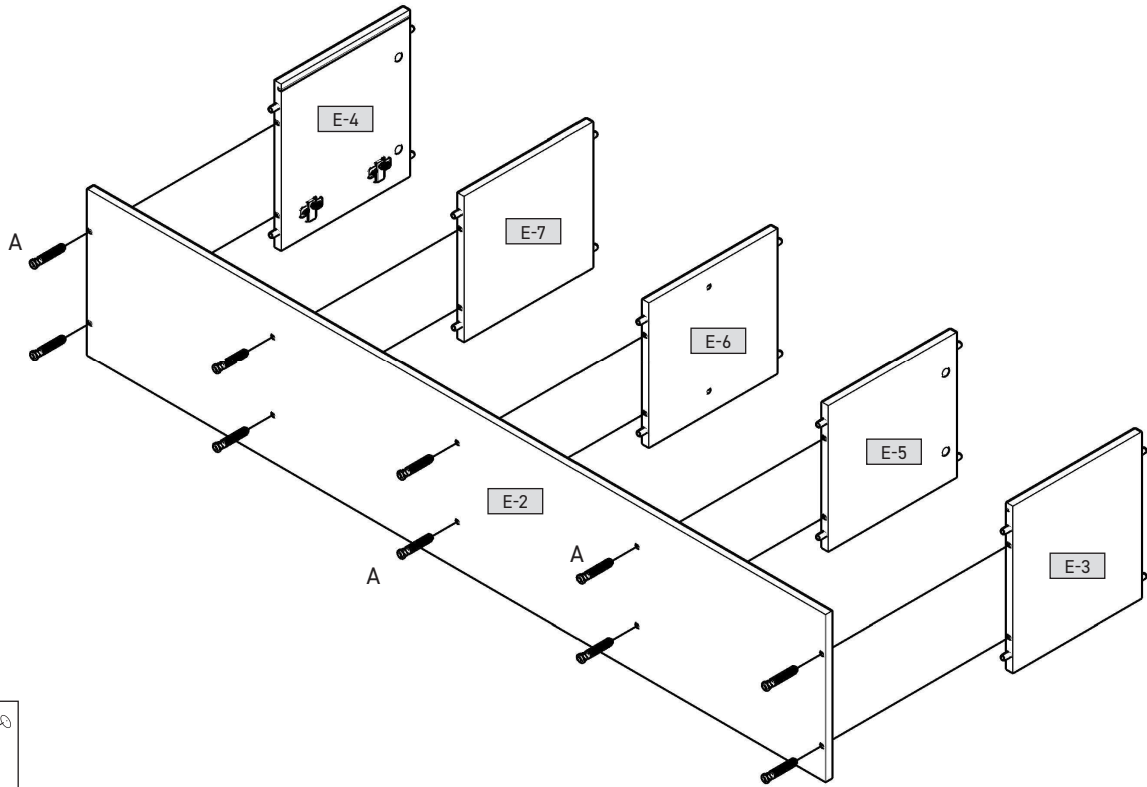

4

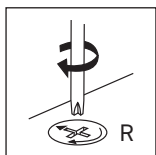
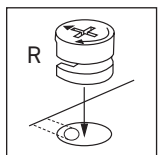
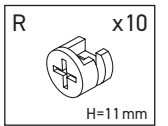
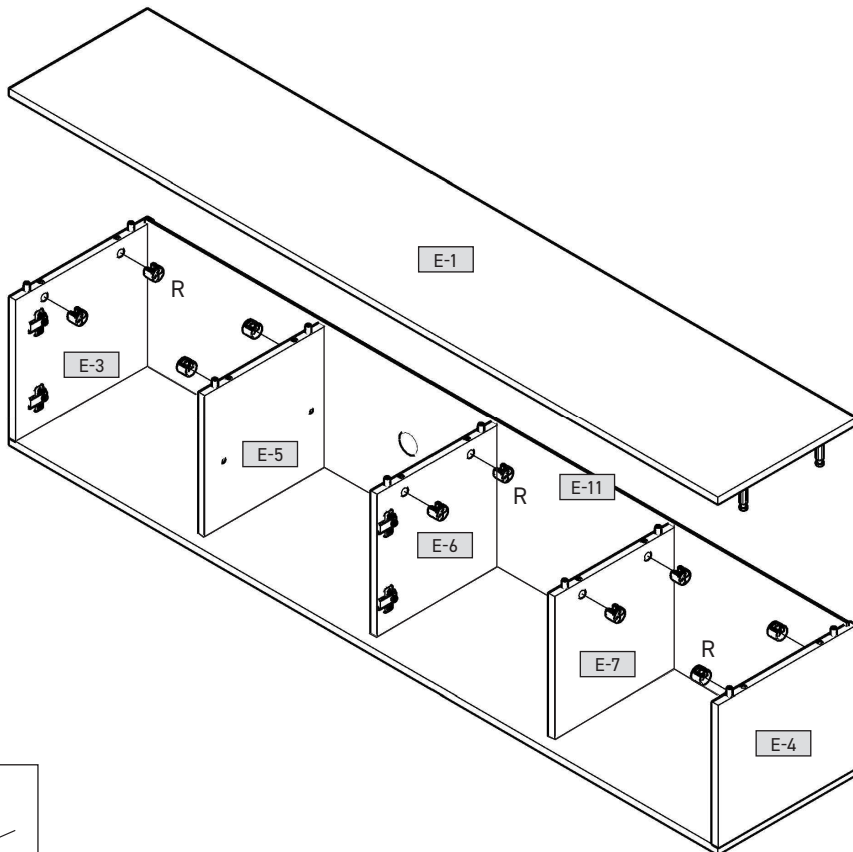

# 5

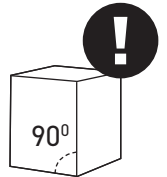
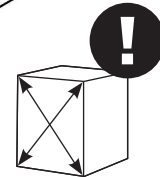
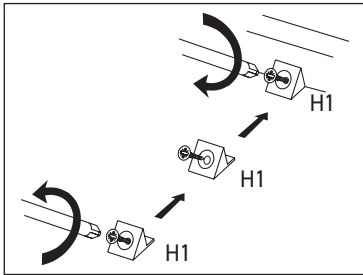
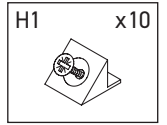
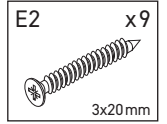
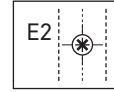
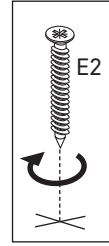
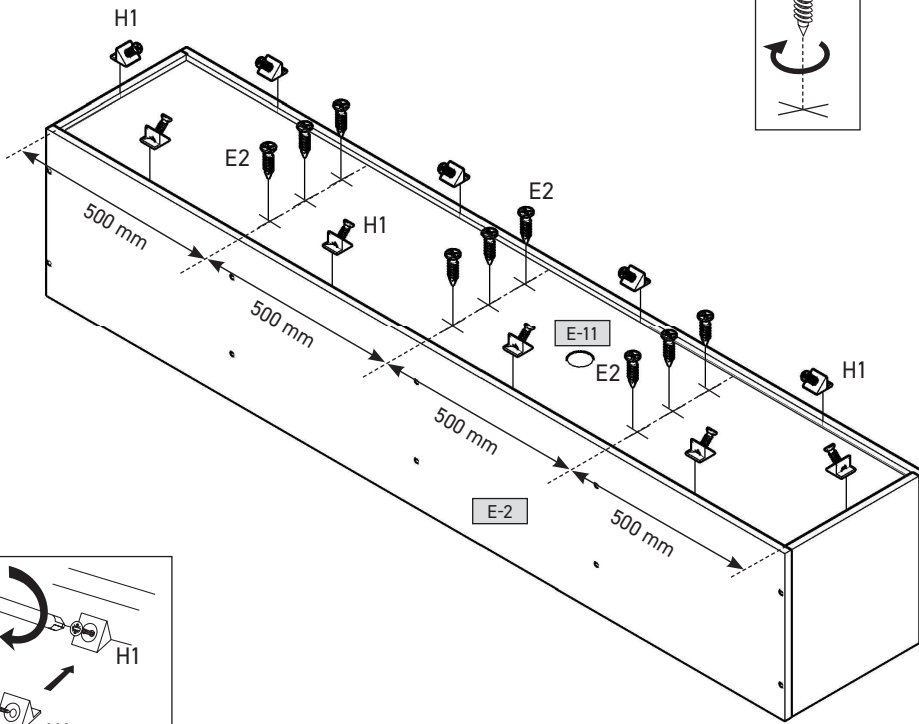

# 6

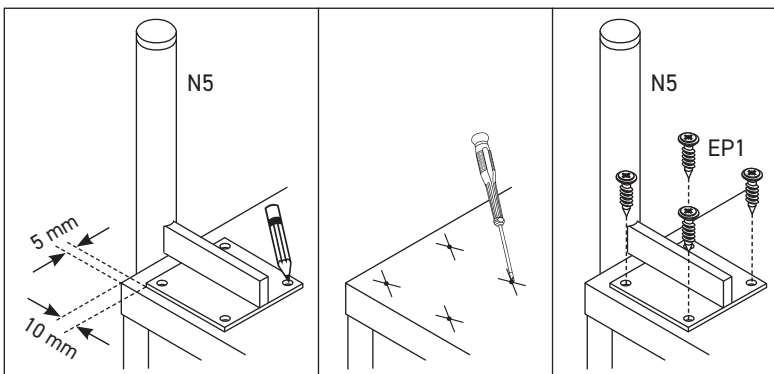
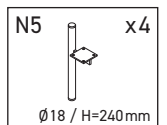
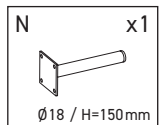
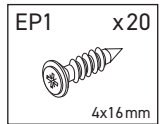
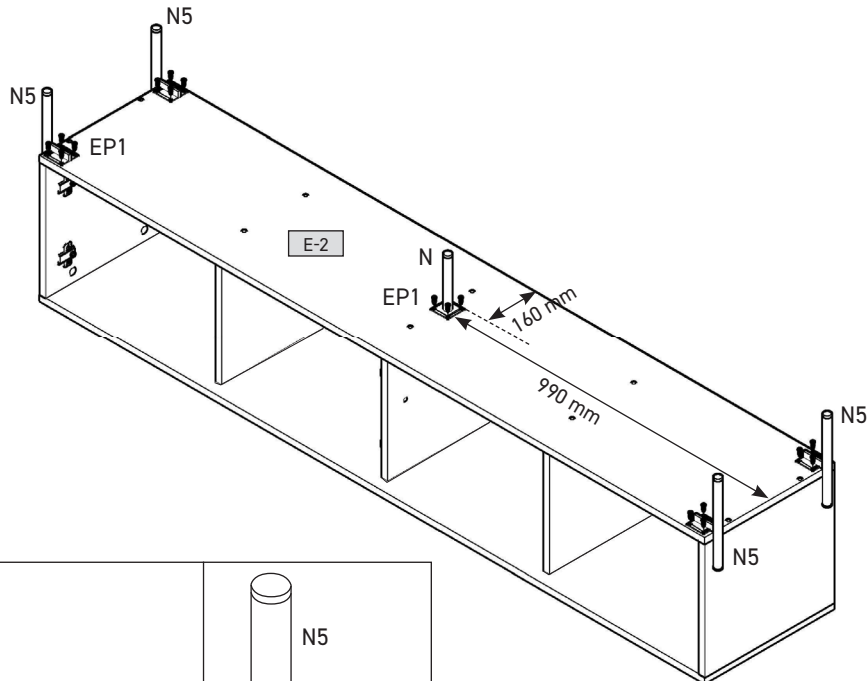

7

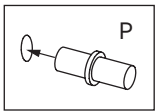
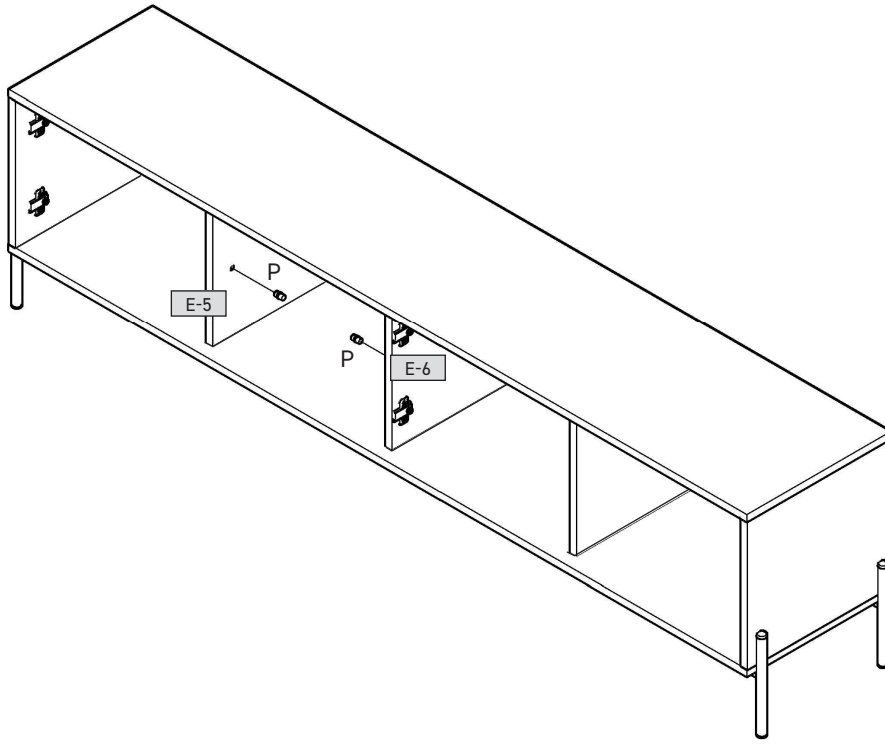
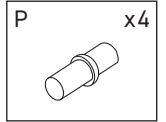
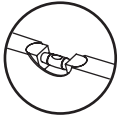

8

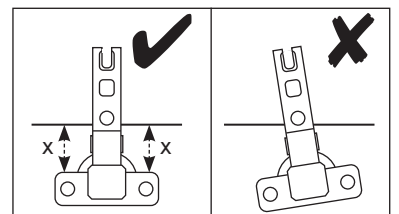
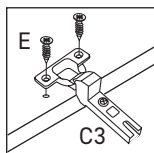
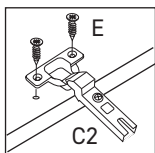
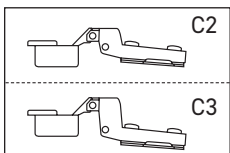
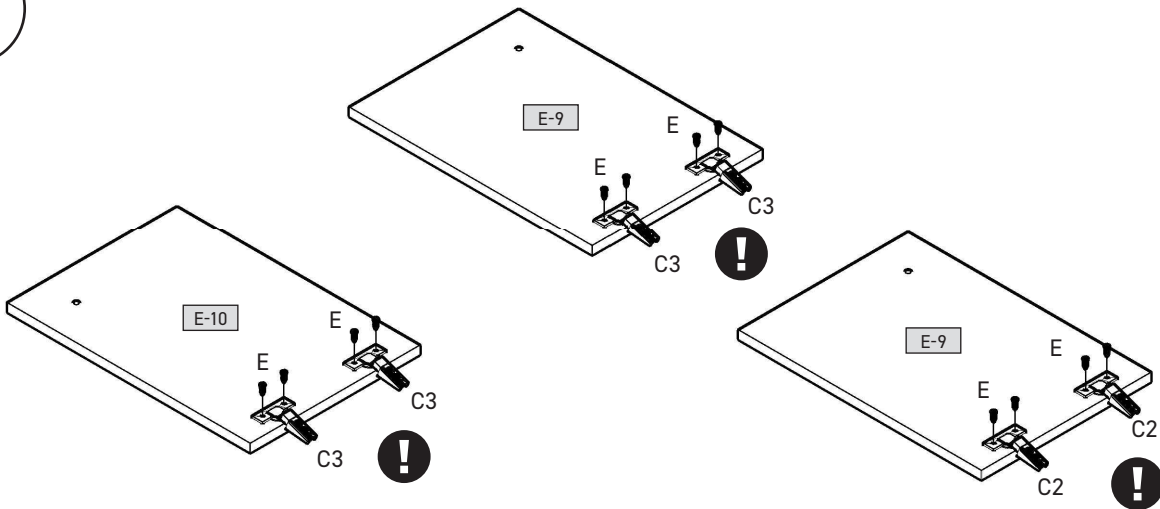
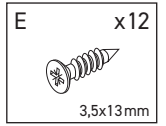
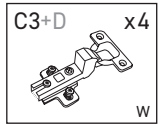
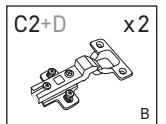

9

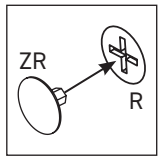
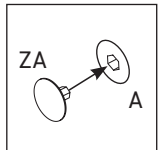
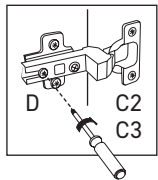
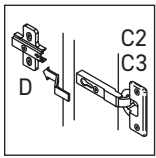
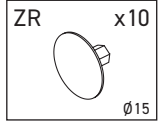
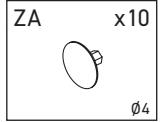
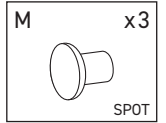
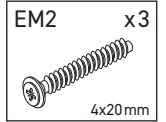
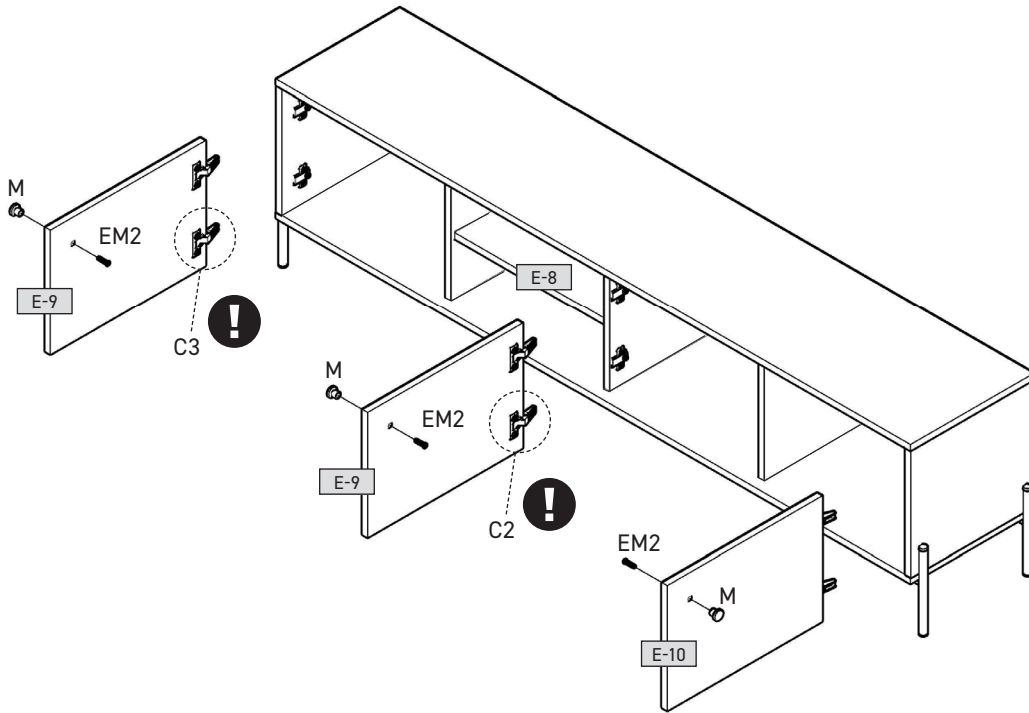

10

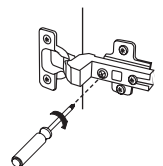
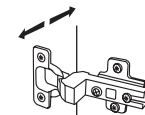
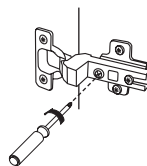
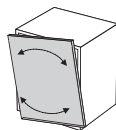
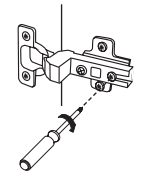
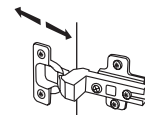
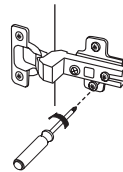
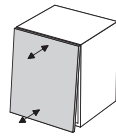
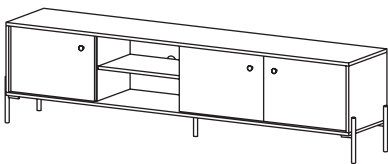
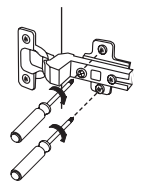
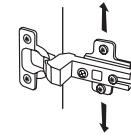
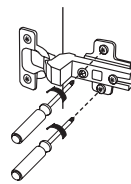
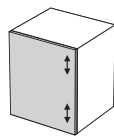



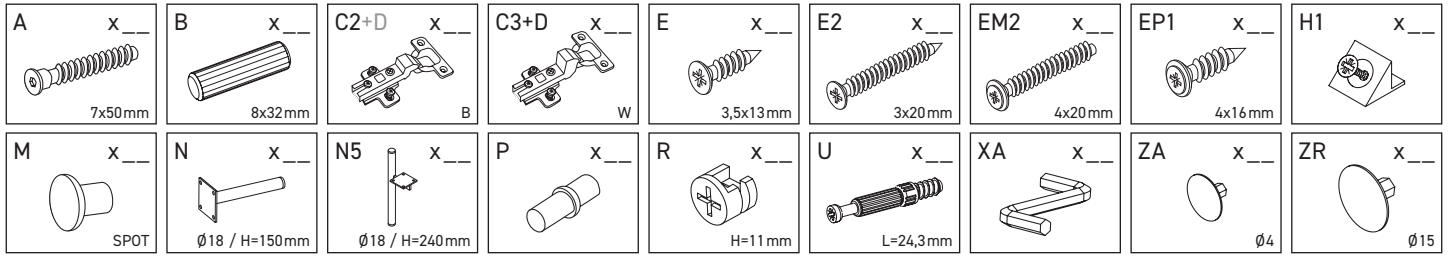

E-1	2029	395	16	x1	1/2
E-2	2029	395	16	x1	1/2
E-3	352	394	16	x1	1/2
E-4	352	394	16	x1	1/2
E-5	352	345	16	x1	1/2
E-6	352	345	16	x1	1/2
E-7	352	345	16	x1	1/2
E-8	482	335	16	x1	1/2
E-9	346	496	16	x2	1/2
E-10	346	496	16	x1	1/2
E-11	2010	366	3	x1	1/2

