

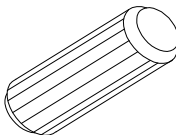

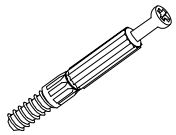







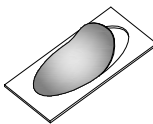
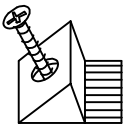
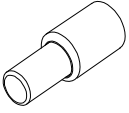

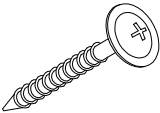
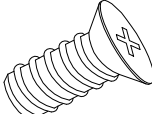
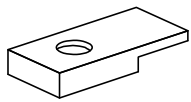
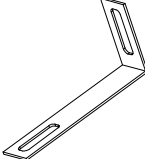
<p>3989</p>  <p>Ø8x30mm x12</p>	<p>4066</p>  <p>Ø6.5x36.5mm x22</p>	<p>3996</p>  <p>x22</p>	<p>136239</p>  <p>Ø20 x8</p>
<p>4044</p>  <p>x8</p>	<p>4019</p>  <p>x8</p>	<p>3914</p>  <p>Ø3,0x20 mm x12</p>	<p>3892</p>  <p>Ø4.0x25mm x8</p>
<p>3879</p>  <p>Ø6.3x13mm x8</p>	<p>4076</p>  <p>x12</p>	<p>71900</p>  <p>75x15x32 mm x1</p>	<p>3918</p>  <p>Ø3,5x16mm x2</p>
<p>136858</p>  <p>x4</p>	<p>136917</p>  <p>x4</p>	<p>202689</p>  <p>x4</p>	<p>205991</p>  <p>L-1758 mm x1</p>

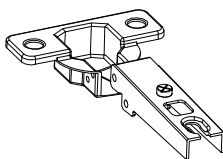
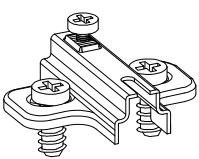
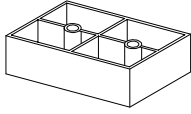
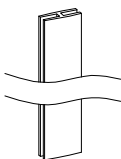
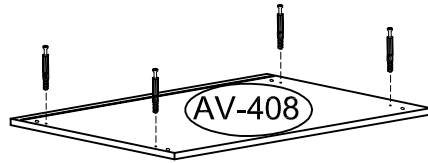
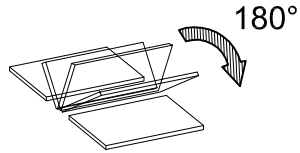
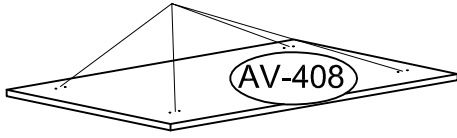
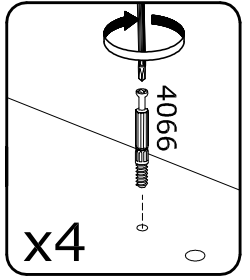
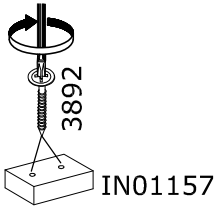
1

4066  x4	3892  x8	IN01157  x4		
--	--	---	--	---



2

3996  x8	3989  x8	4019  x4	136917  x4	4066  x8		
---	---	---	---	--	--	---

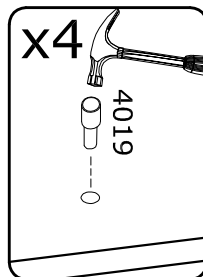
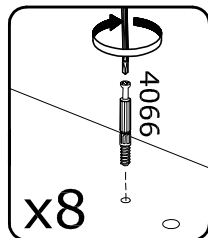
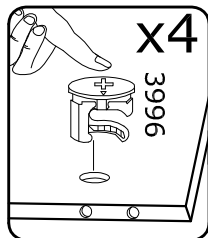
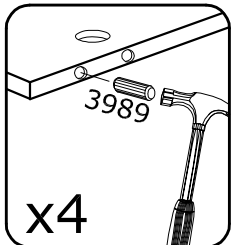
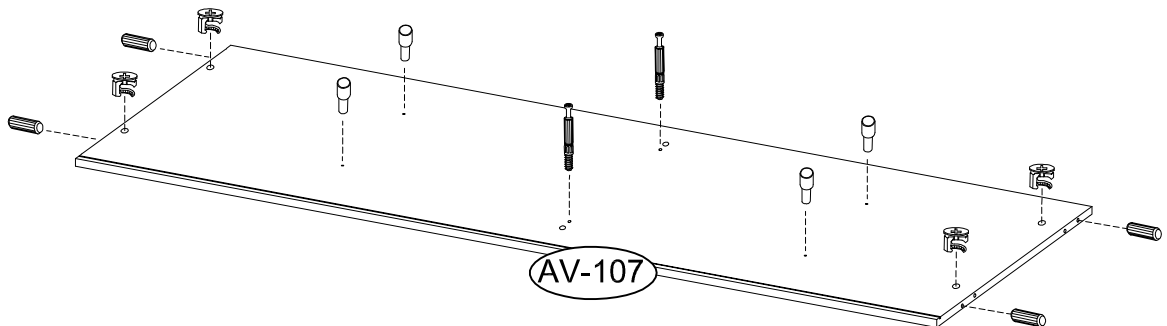
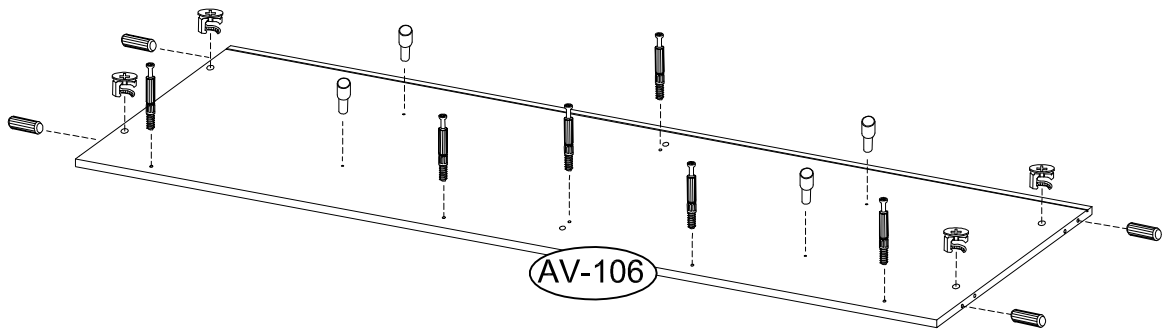

3

3996



x4

3989



x4

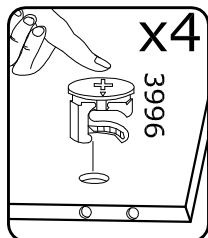
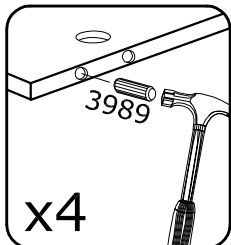
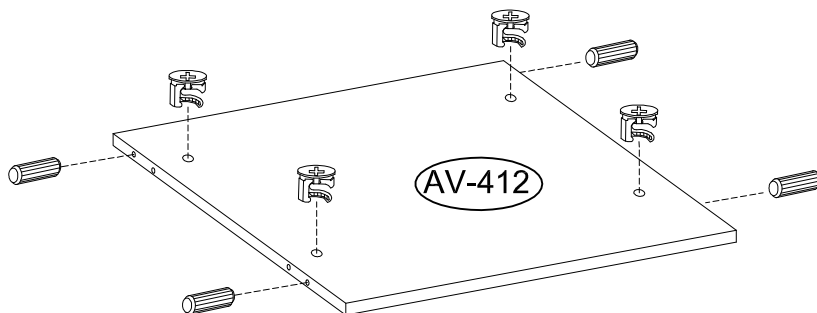

4

4066



x6

3996



x2

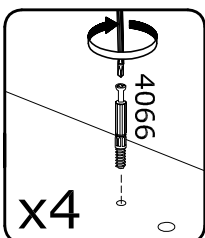
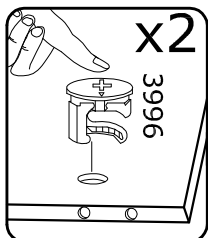
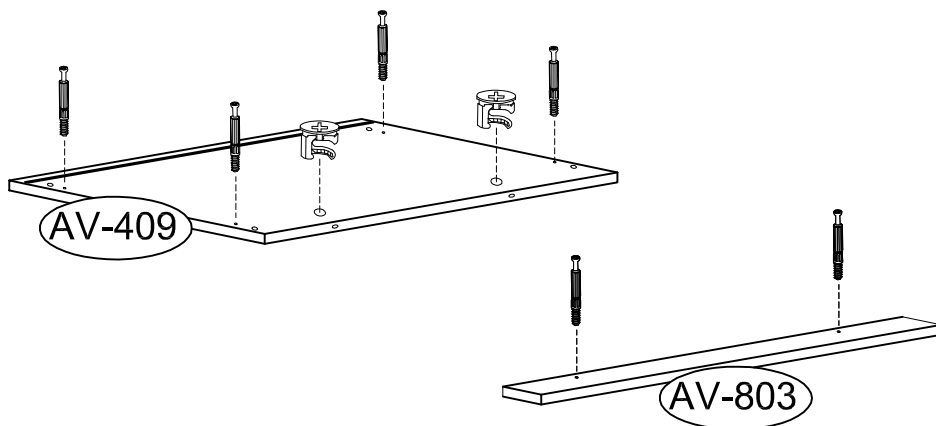

5

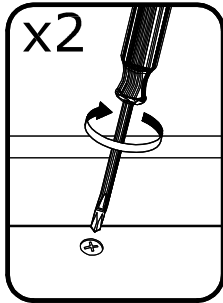
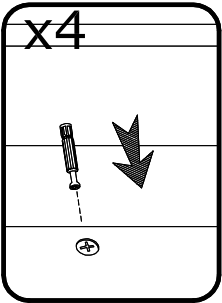
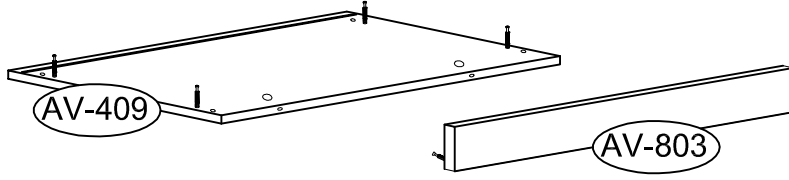
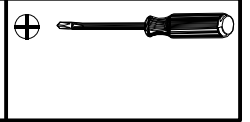

6

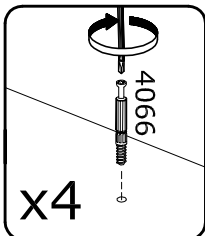
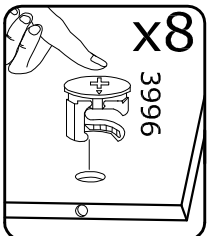
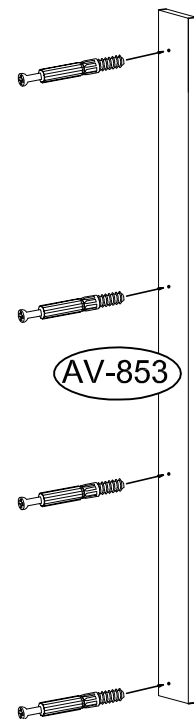
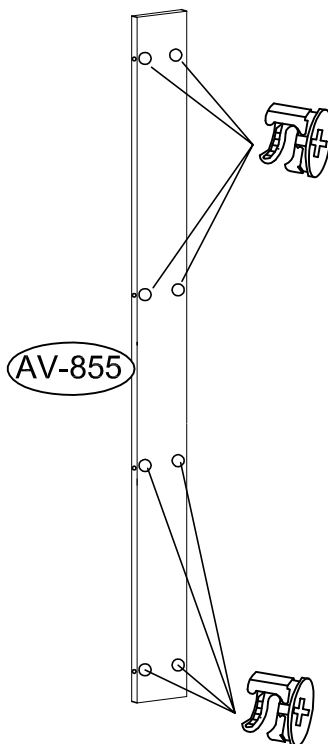
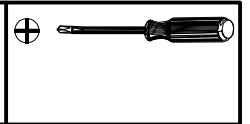
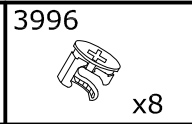
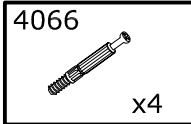

7

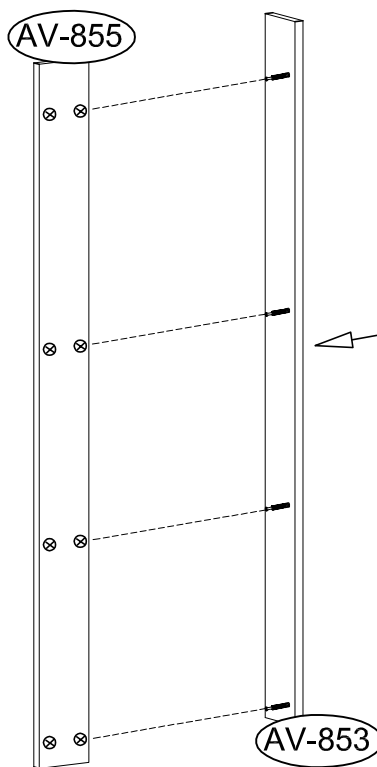
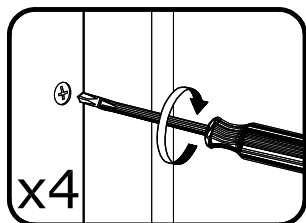
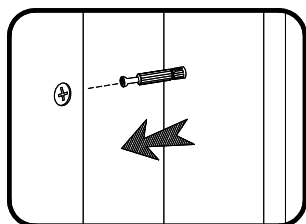

8

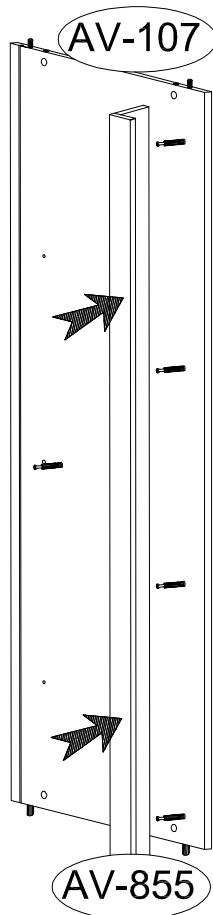
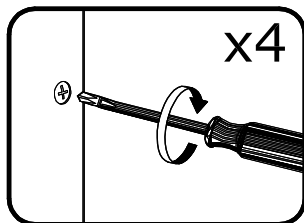
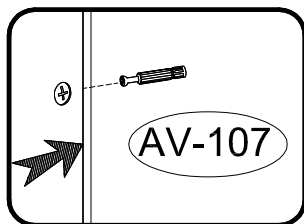
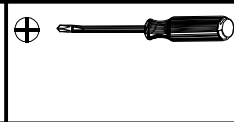

9

136239

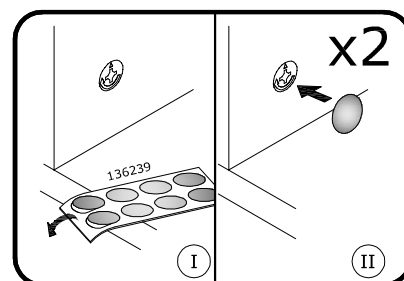
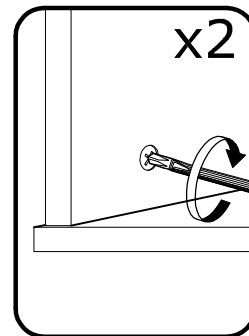
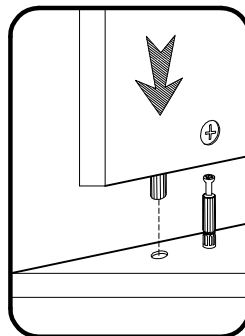
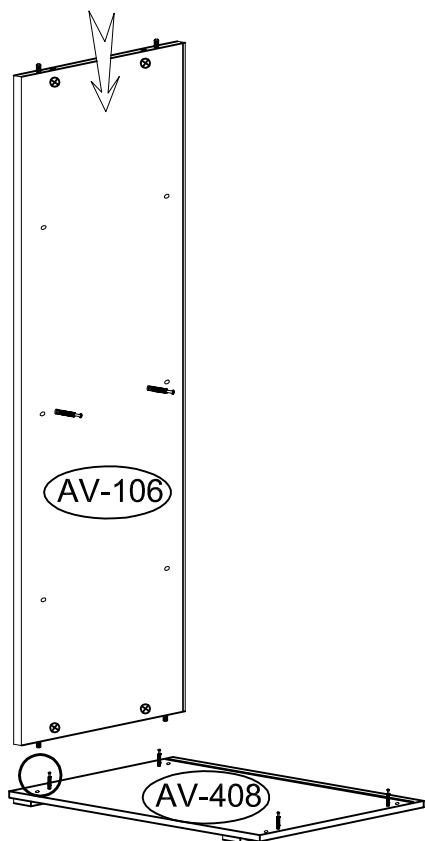

10

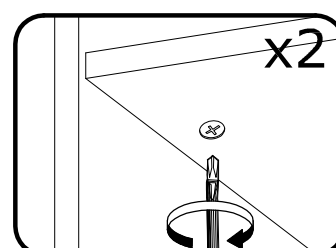
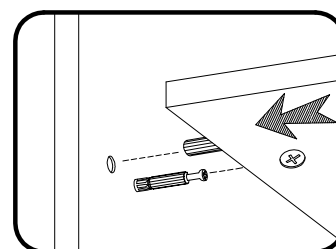
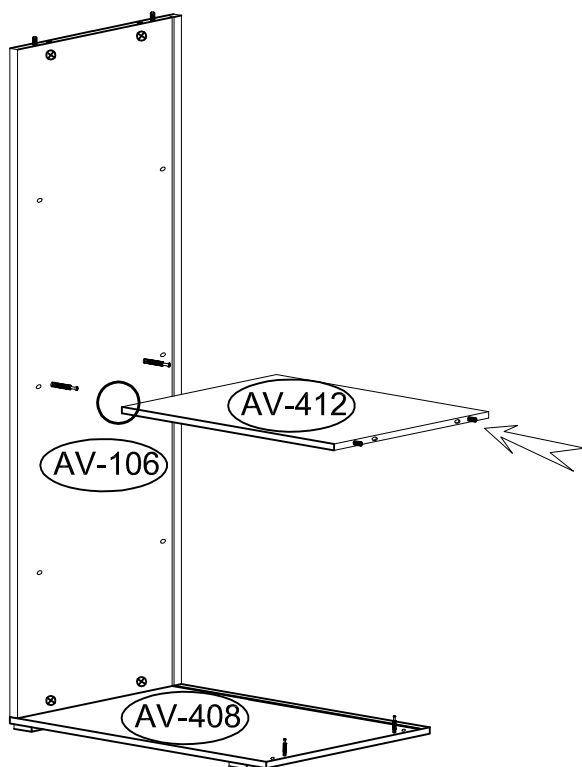

11

136239



x2

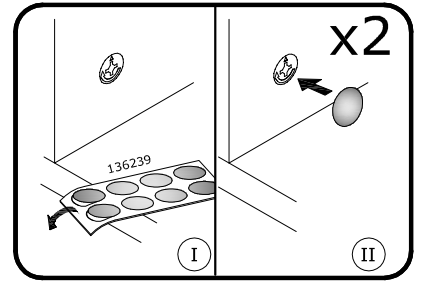
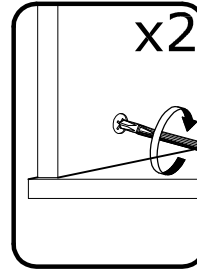
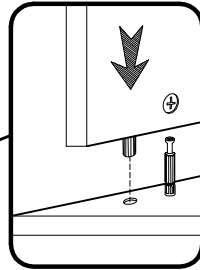
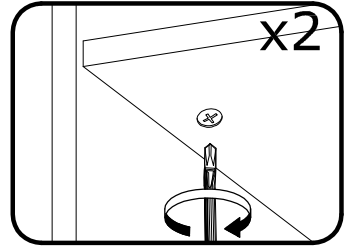
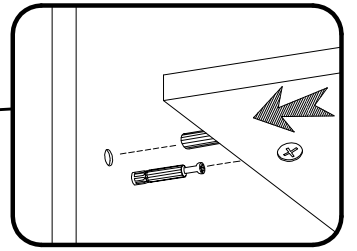
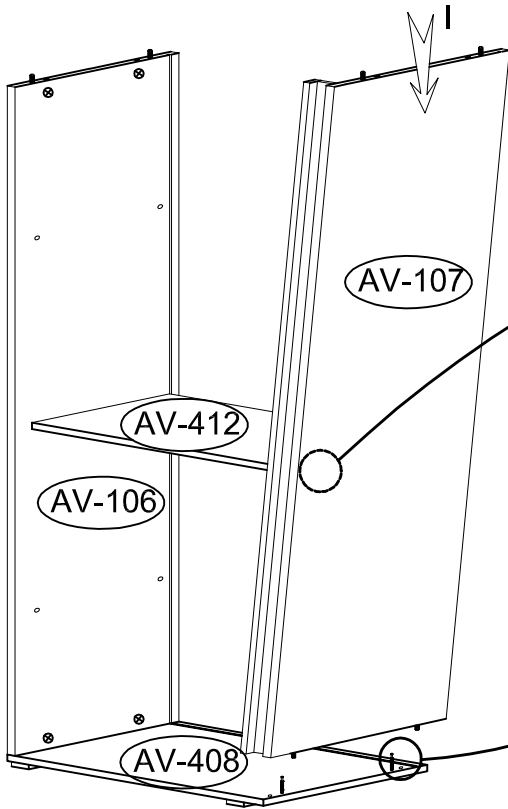

12

136239



x4

136239



x1

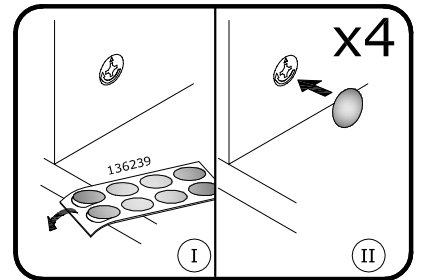
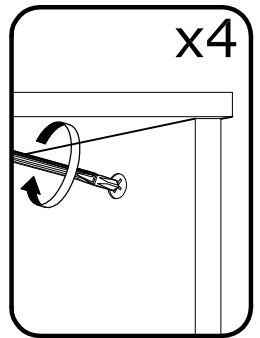
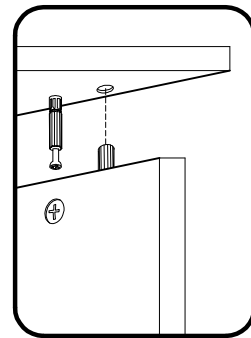
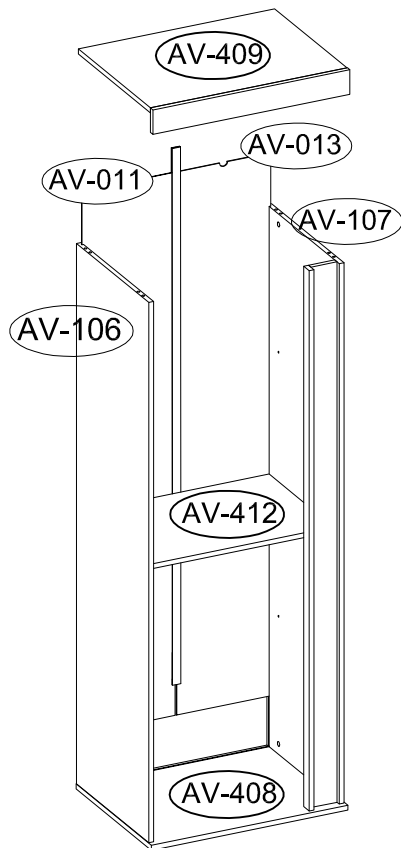

13

136917



x4

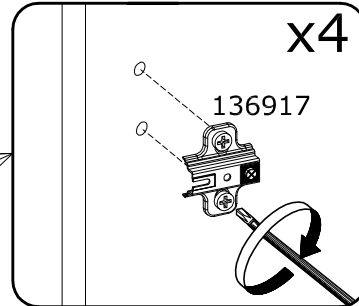
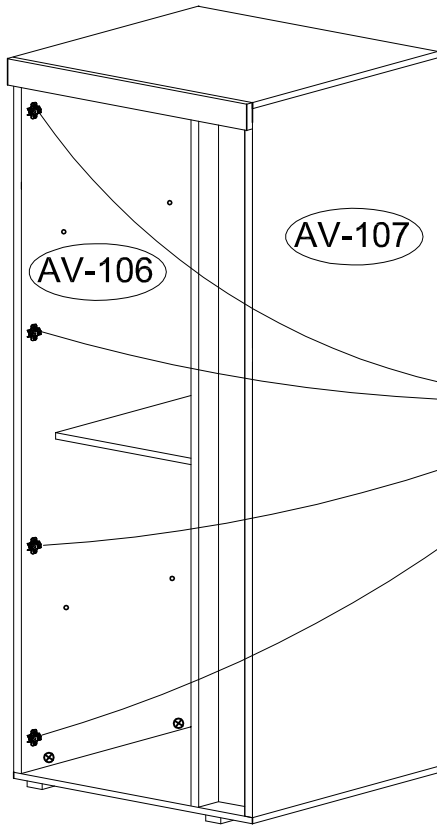

14

4044



x8

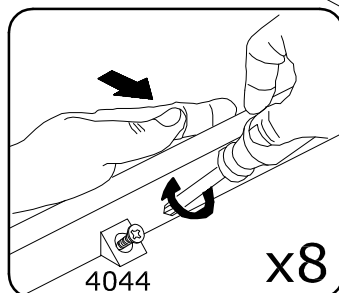
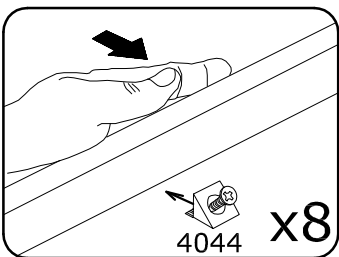
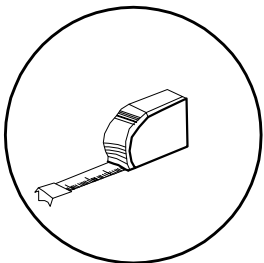
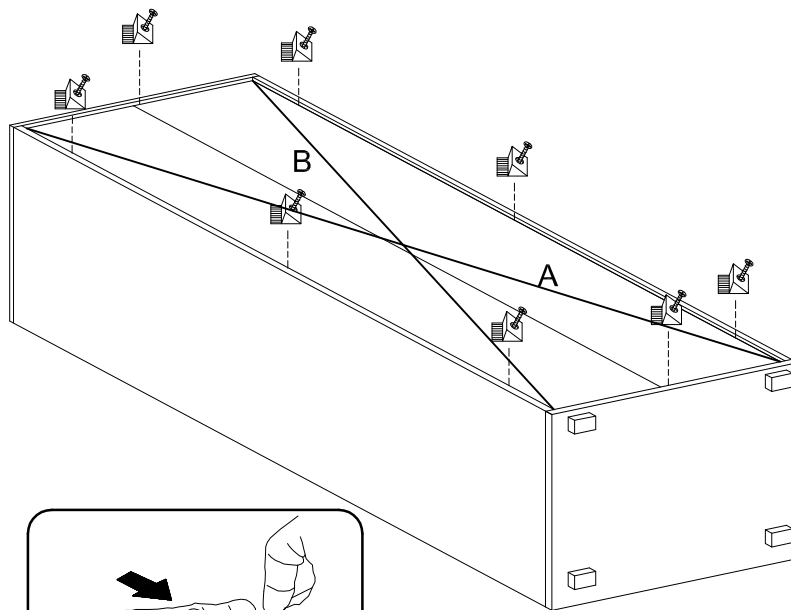

15

4076



x12

3918



x12

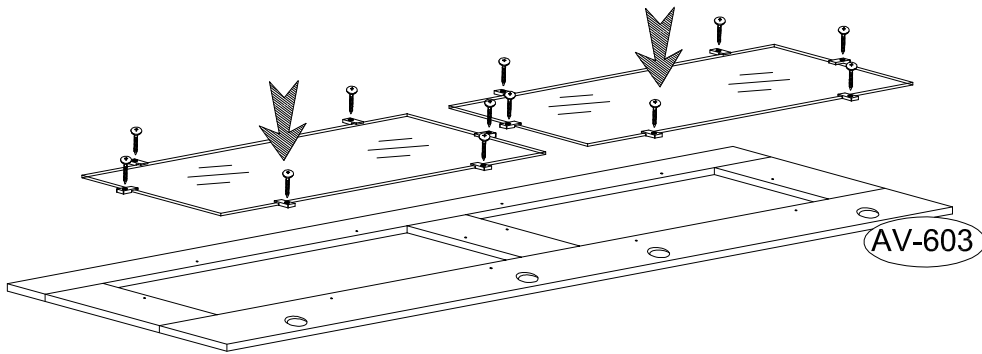
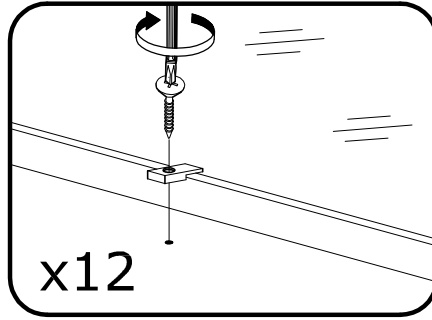

16

136858



x4

3879



x8

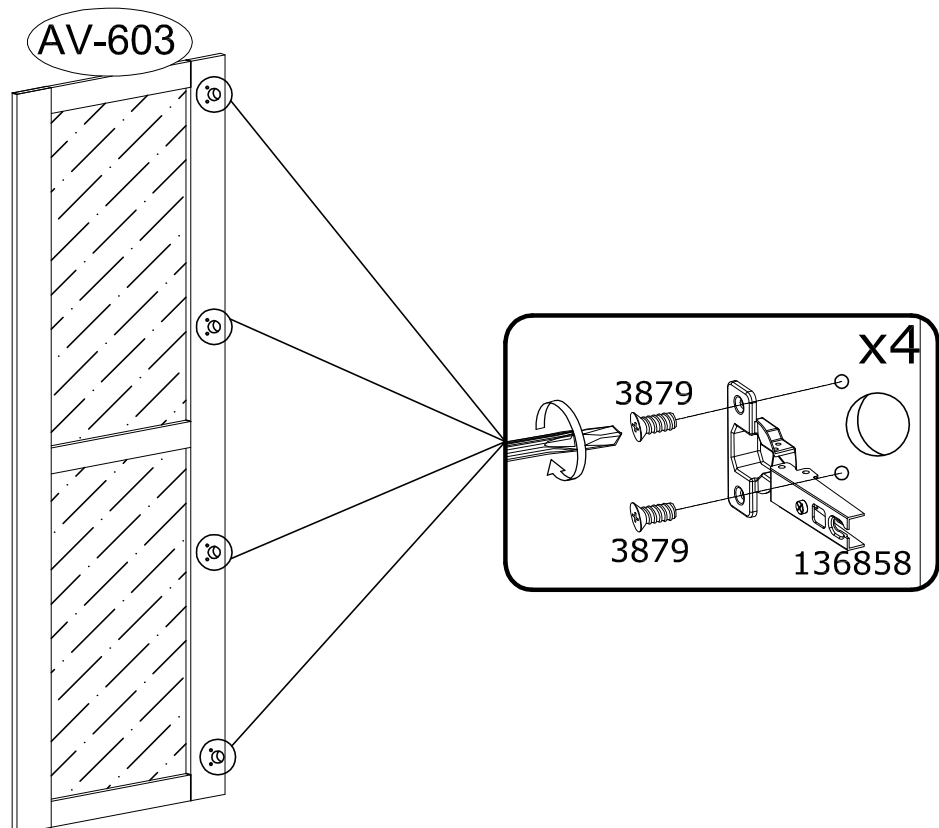

17

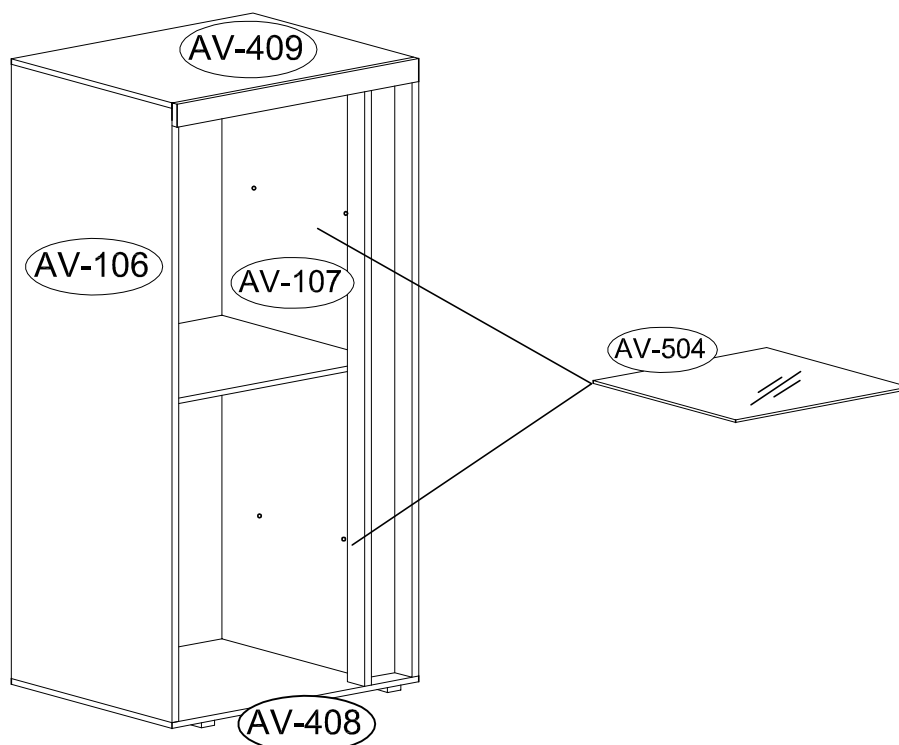

18

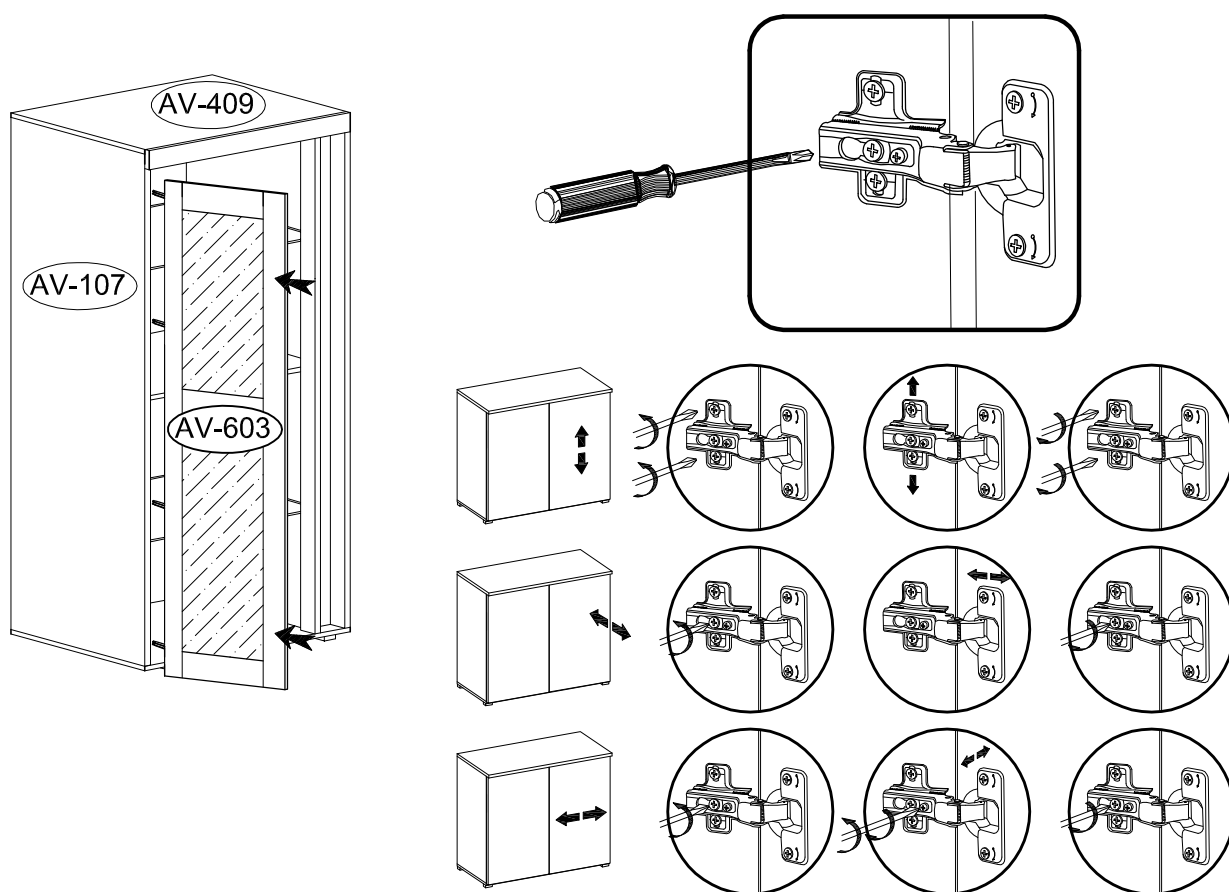

3918



x2

71900



x1

